

星图计划机器人（夹子版）搭建步骤图

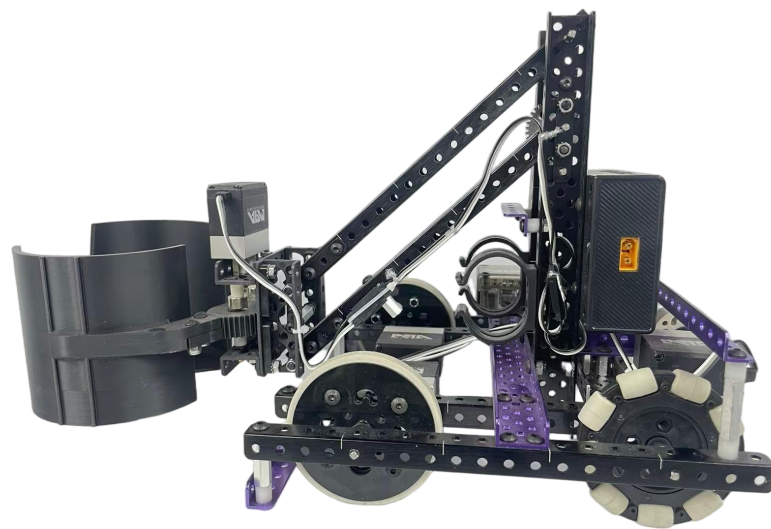

1

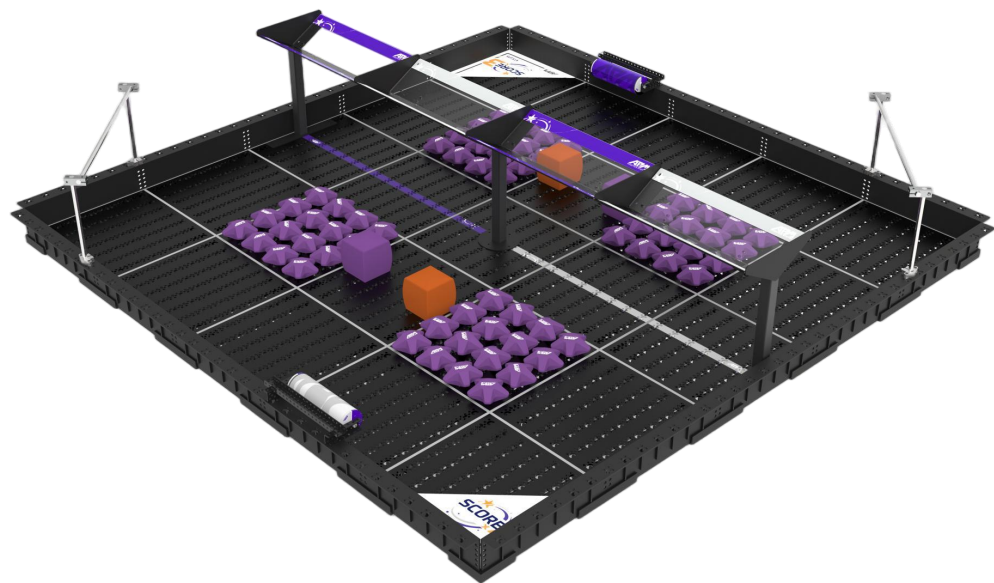
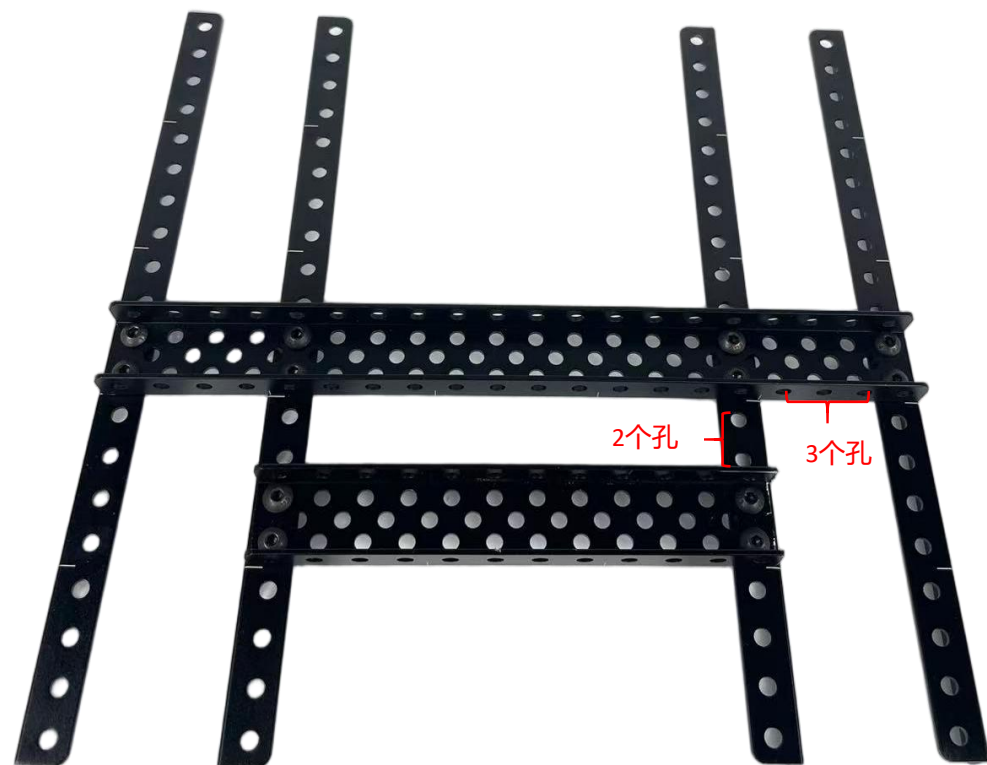

上面

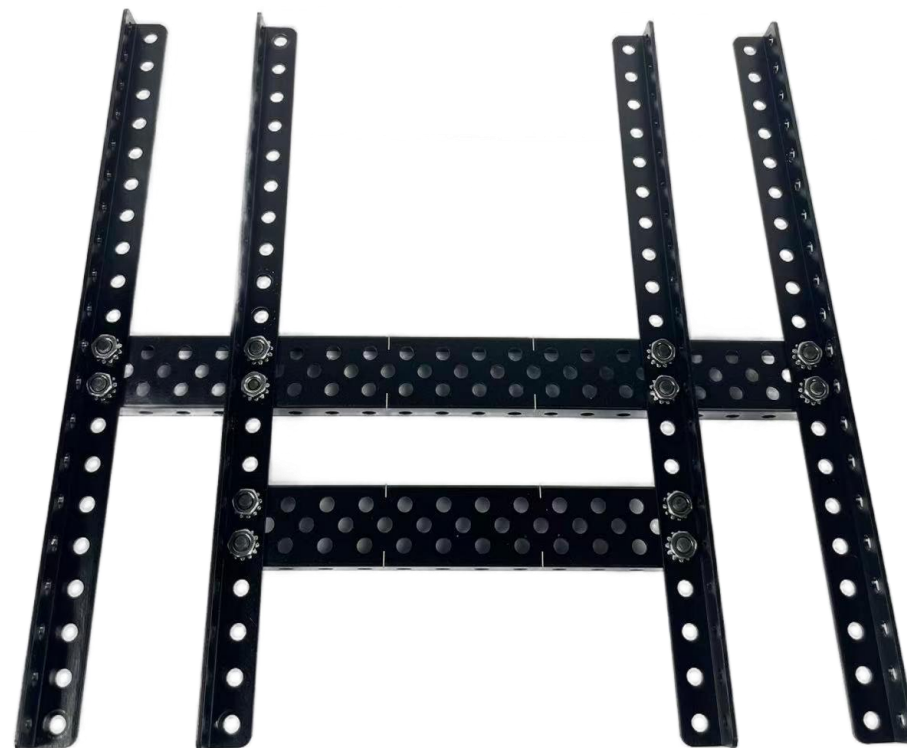

下面

2

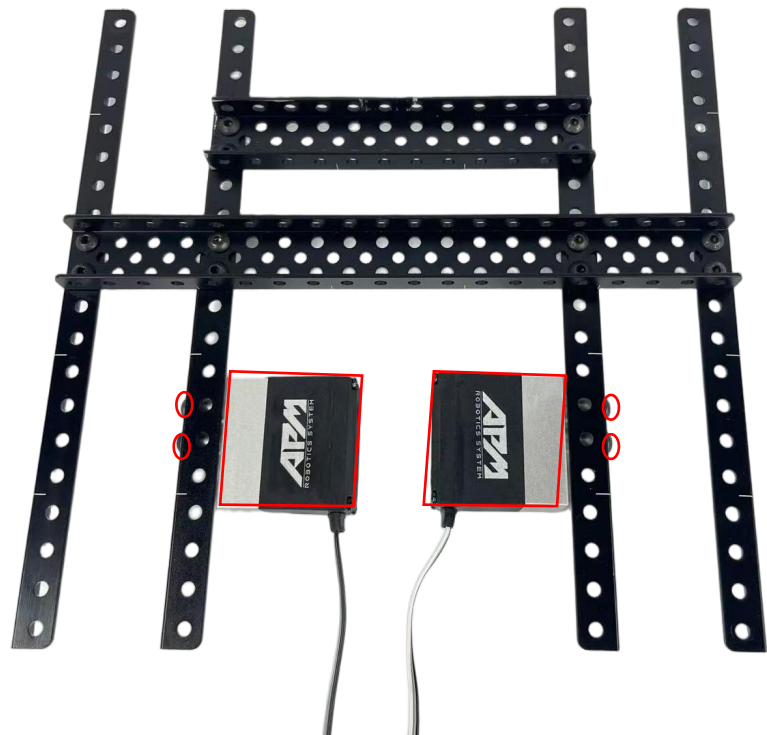
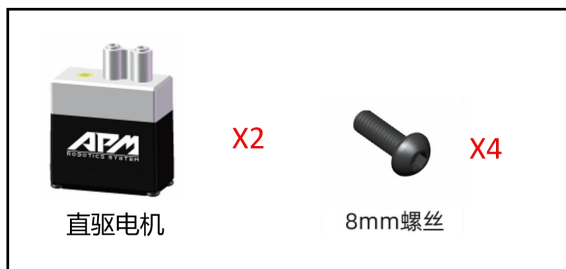

上面

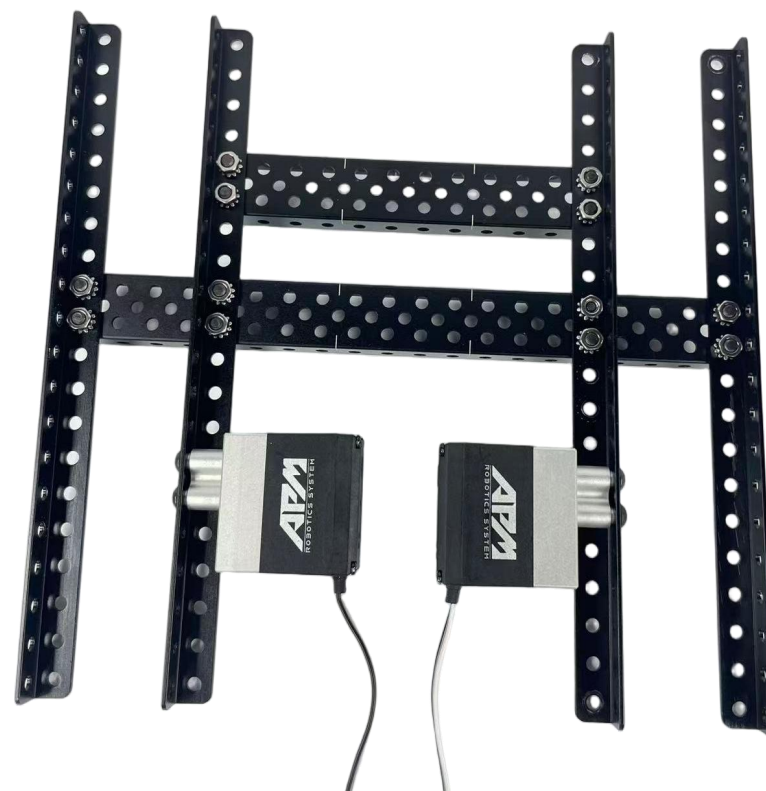

下面

3



上面







下面

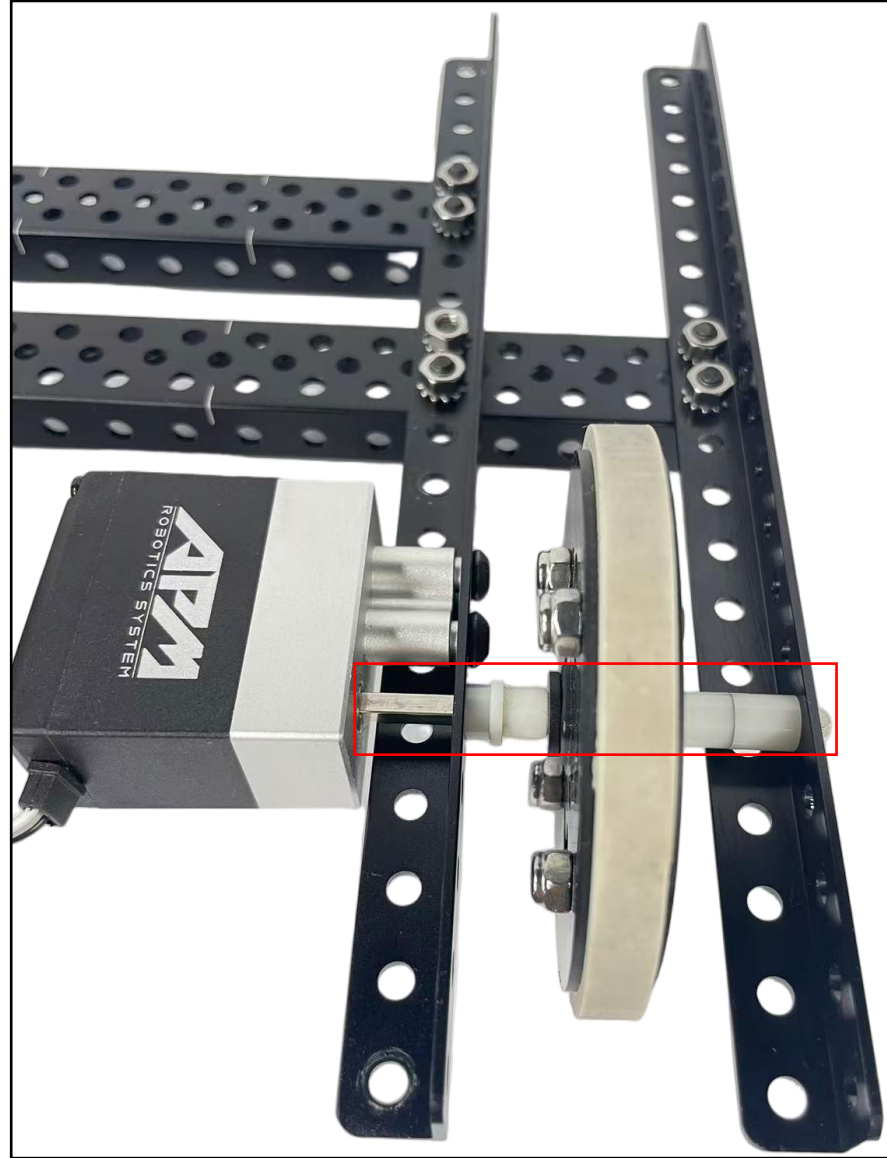
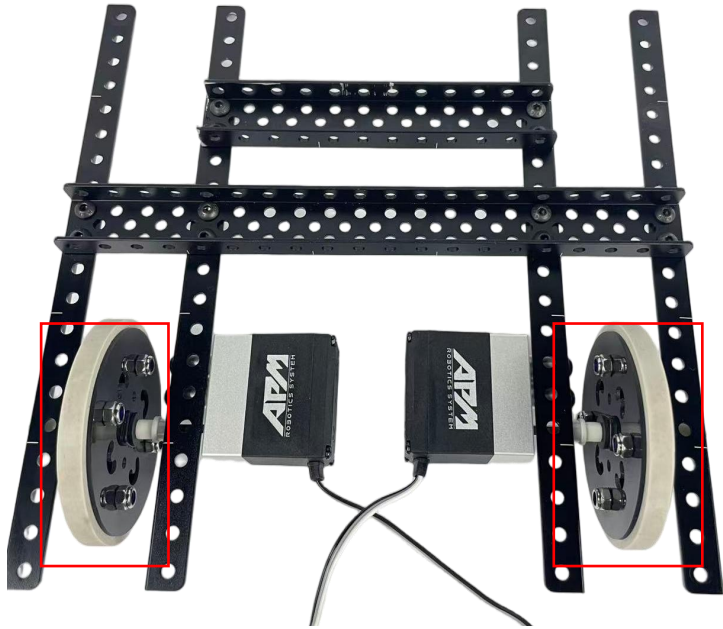

4



4

 X8 金属垫片	 X4 方孔轴芯	 X2 细轴65mm	
 X2 橡胶垫片	 X4 8mm细垫片	 X2 3mm细垫片	 X2 万向轮 单排中号

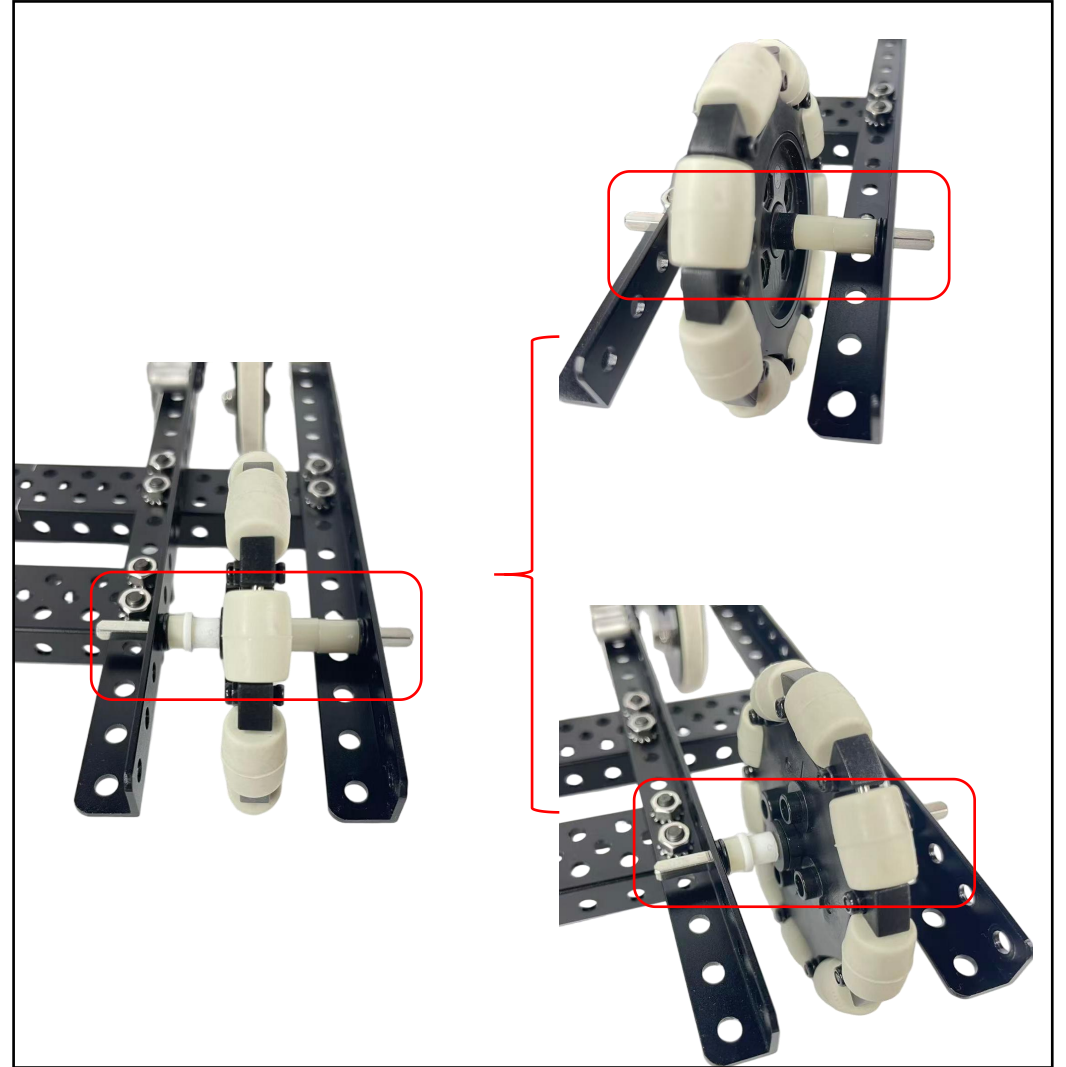
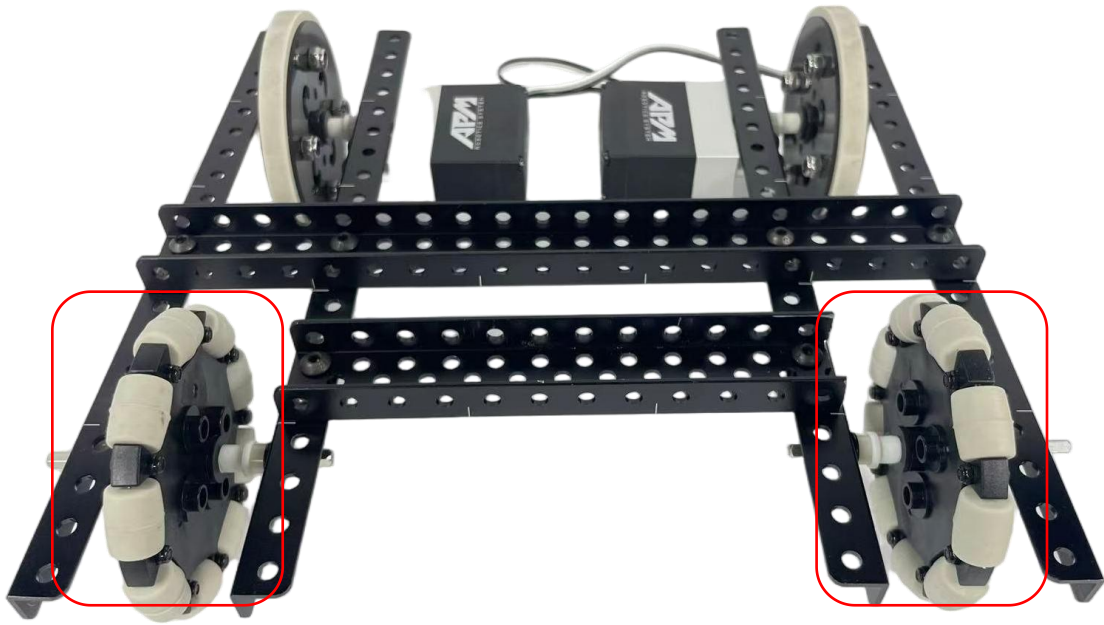

5

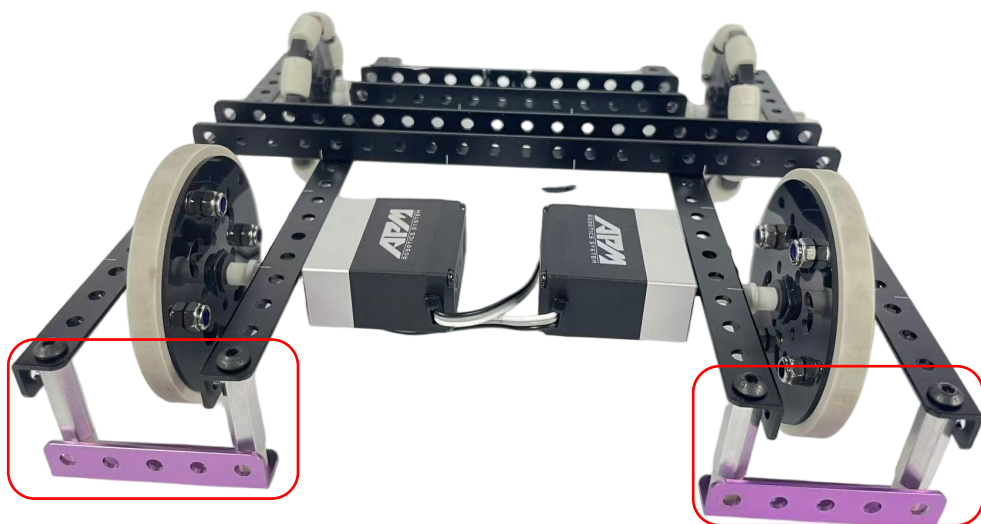

上面

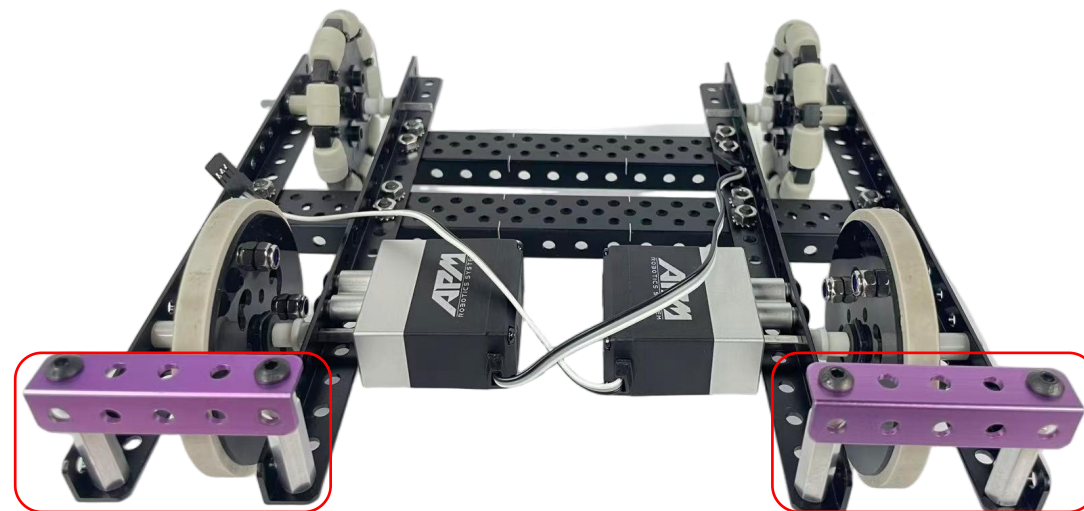

下面

6

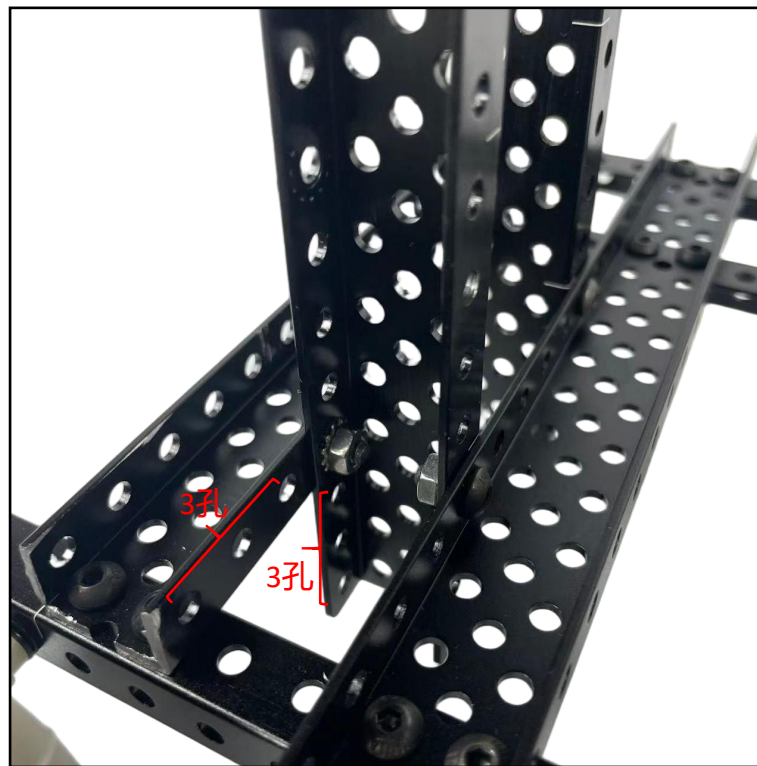
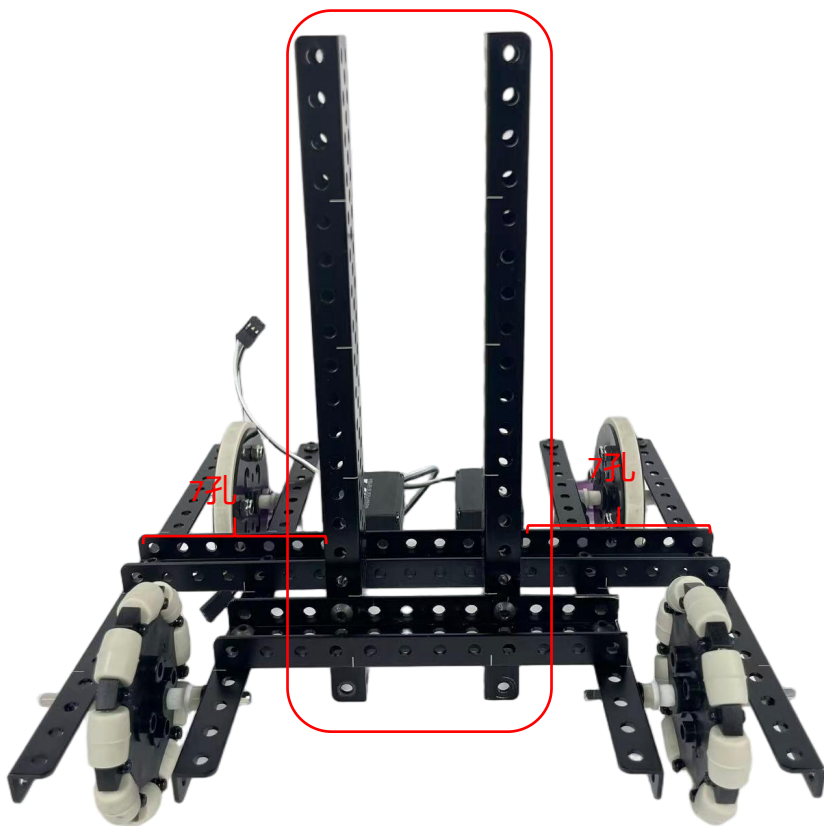

7



8

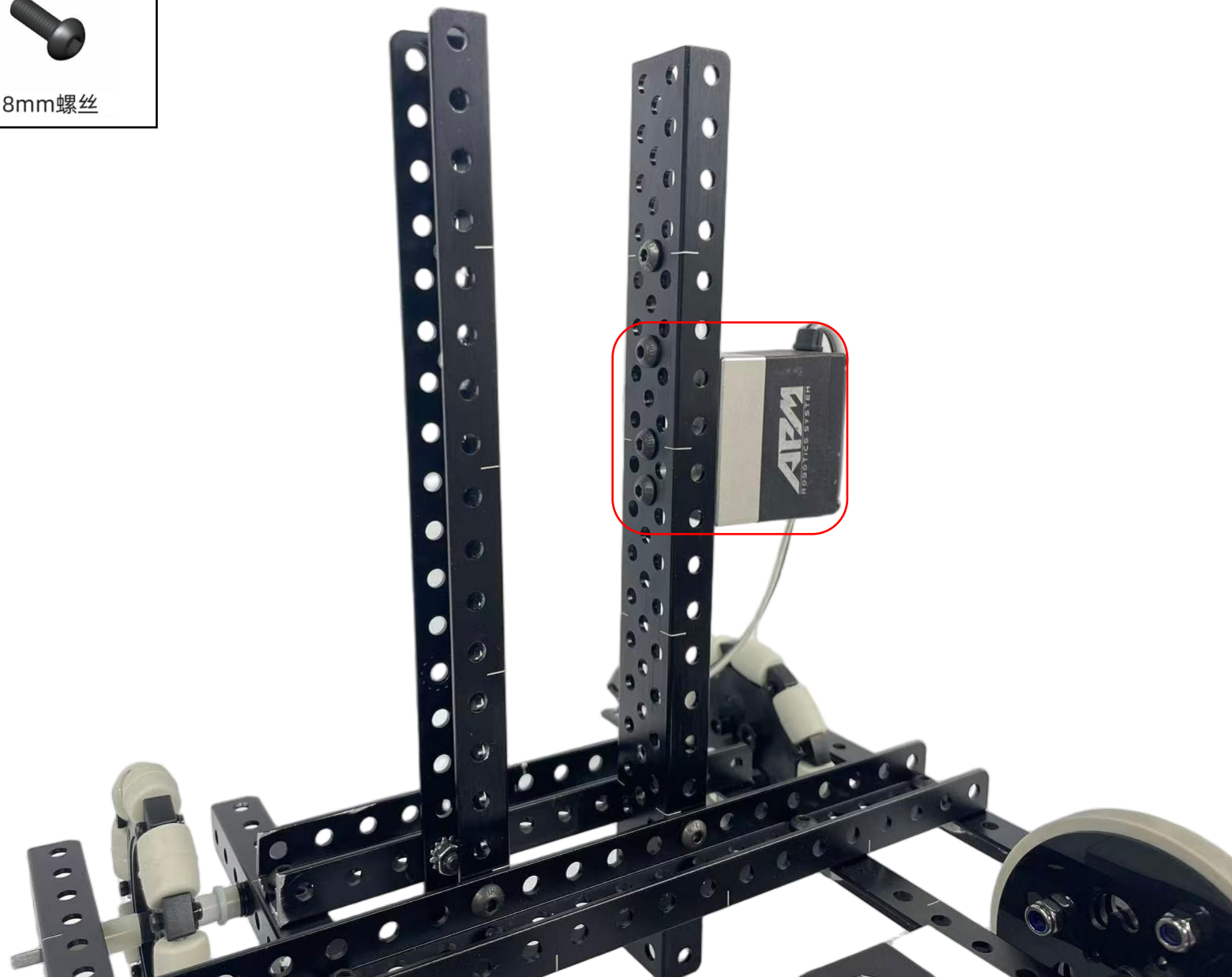

9

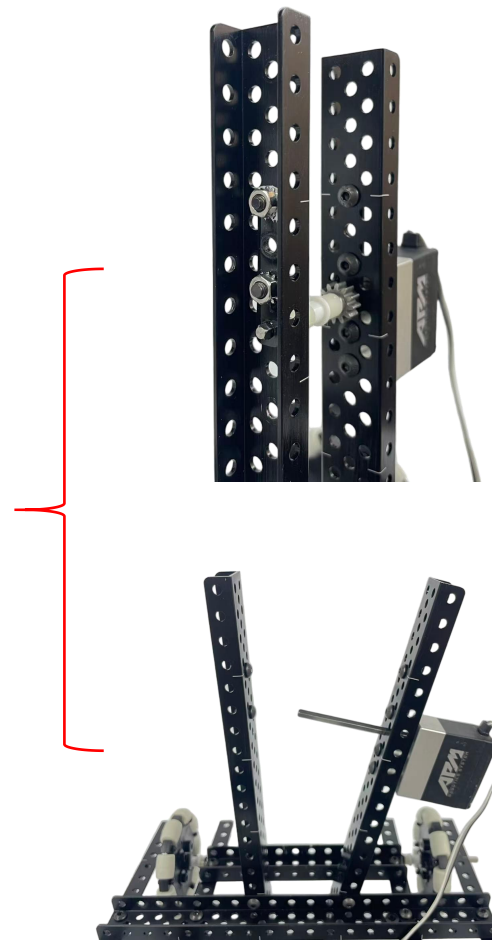
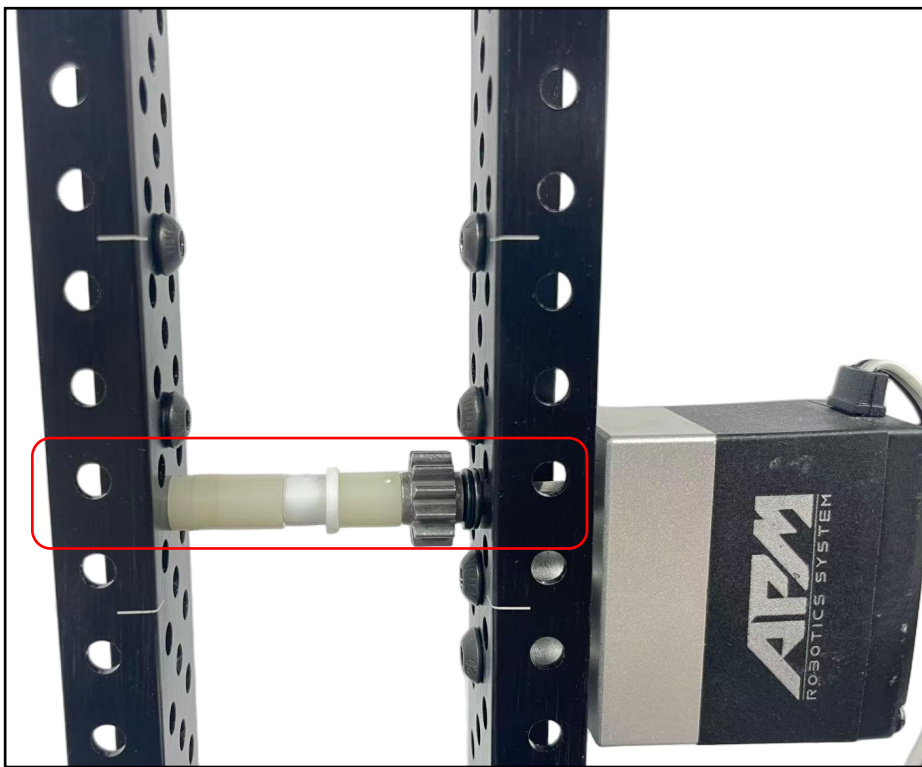
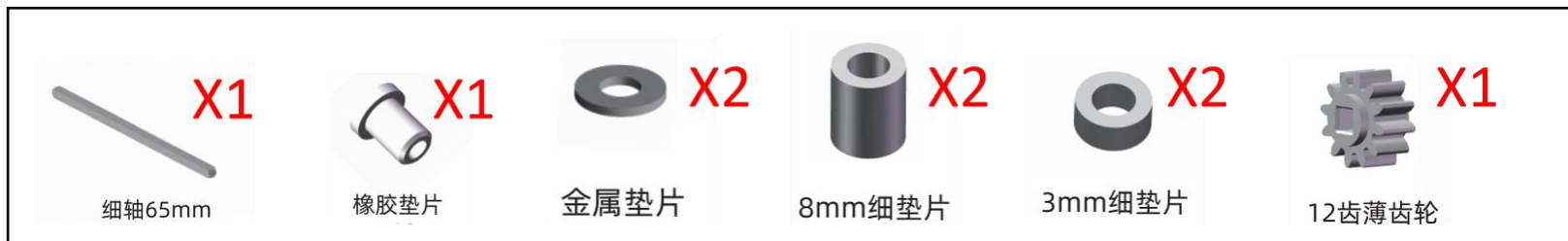

10



11

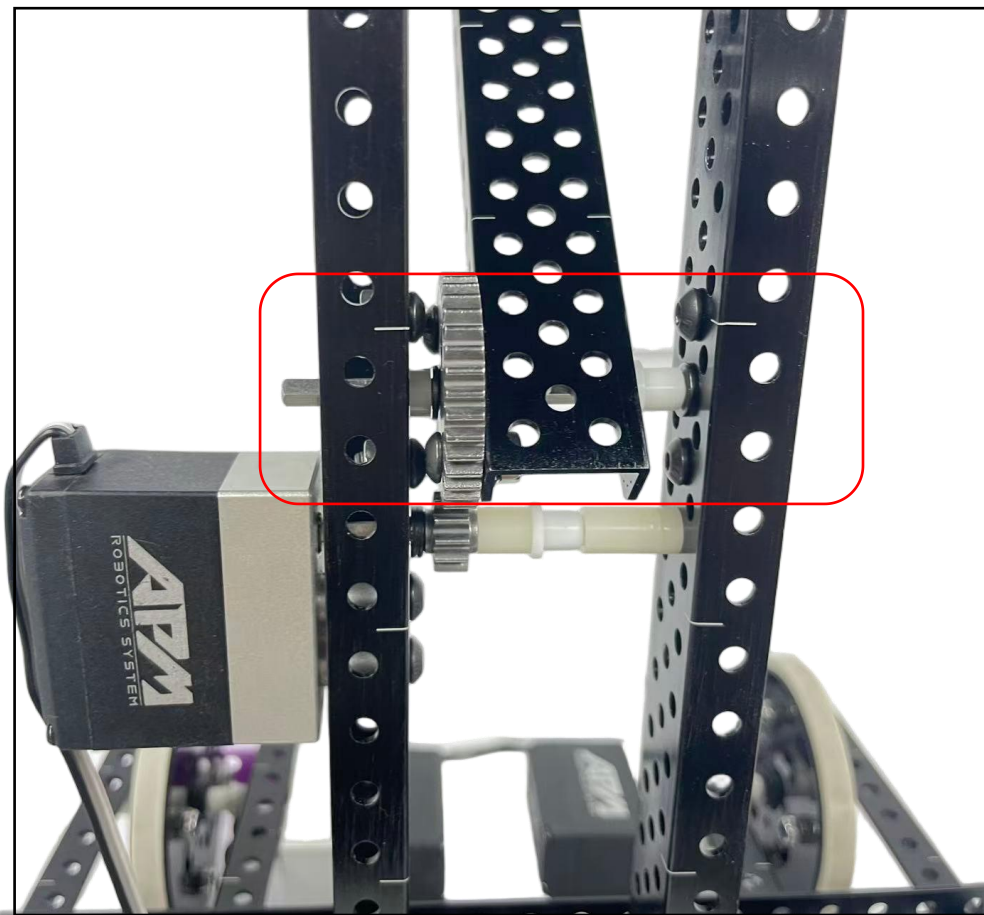
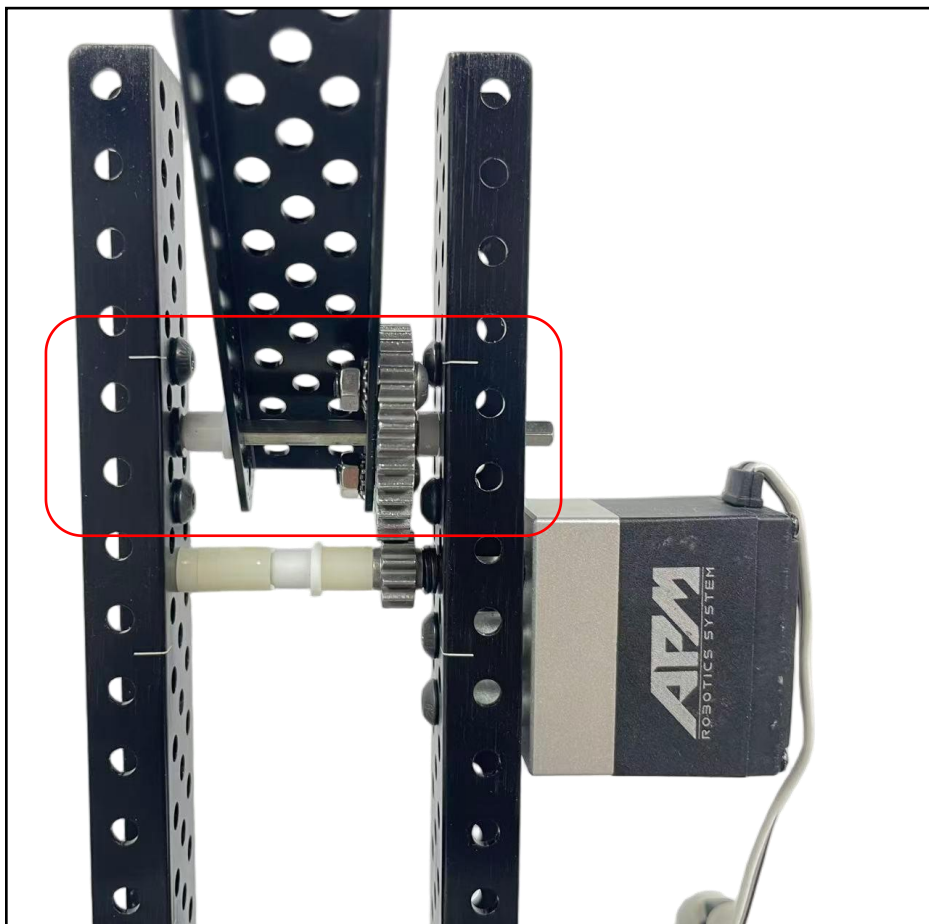
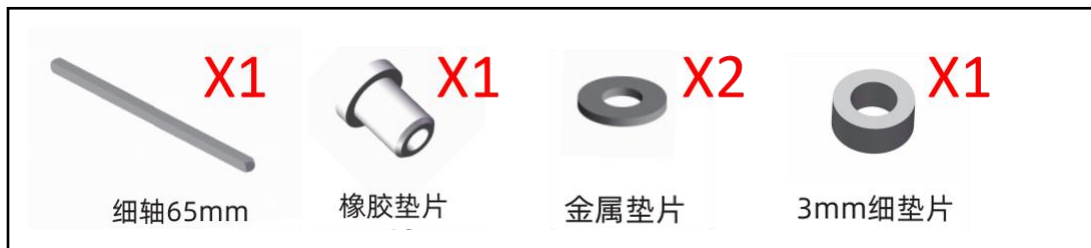

12

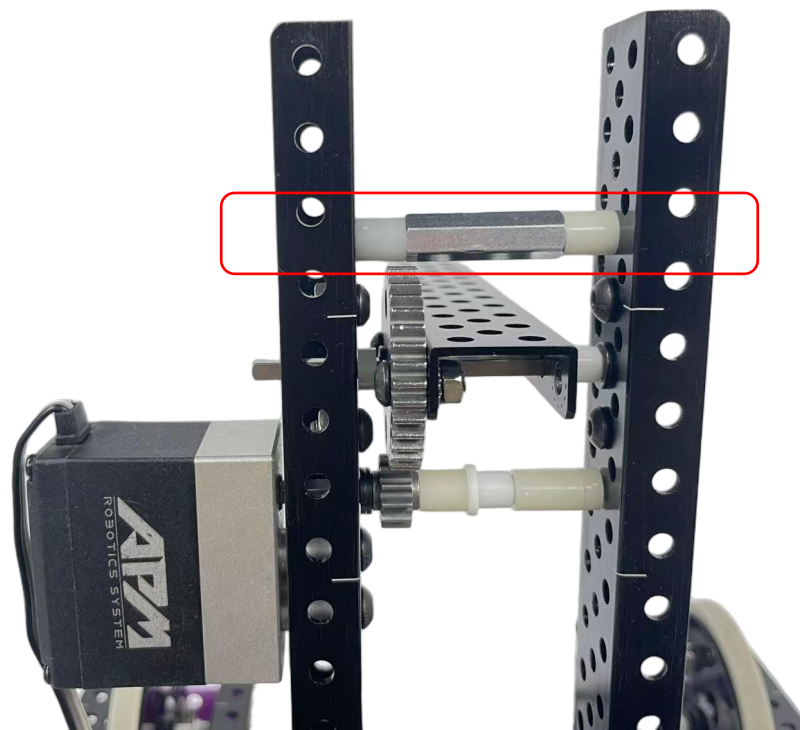
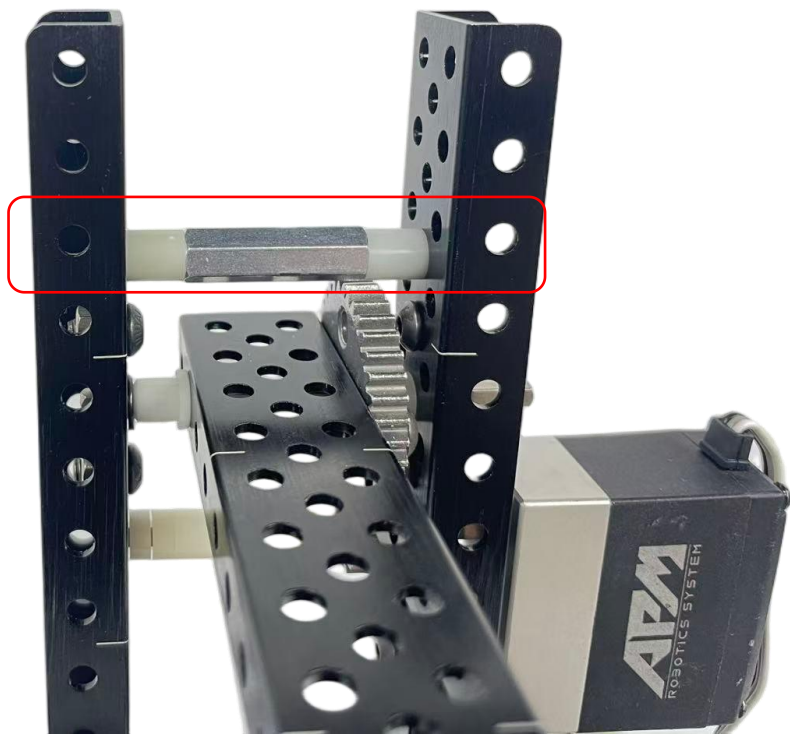

13

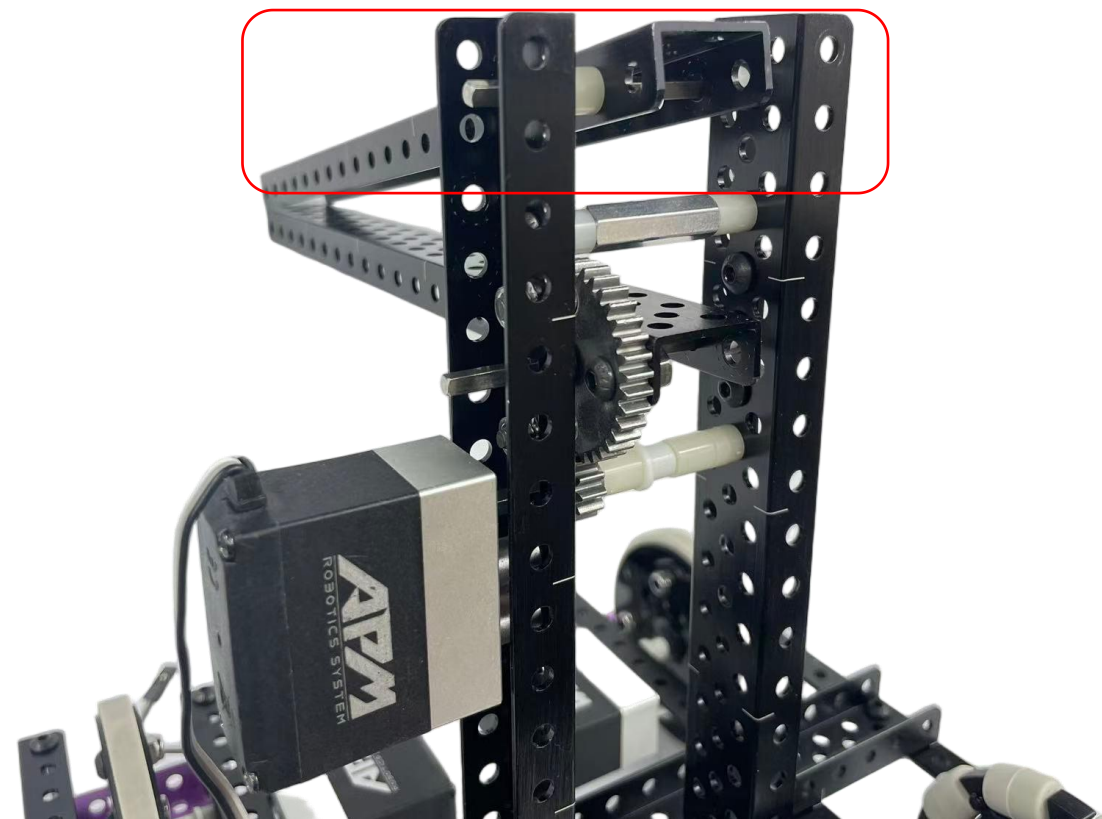
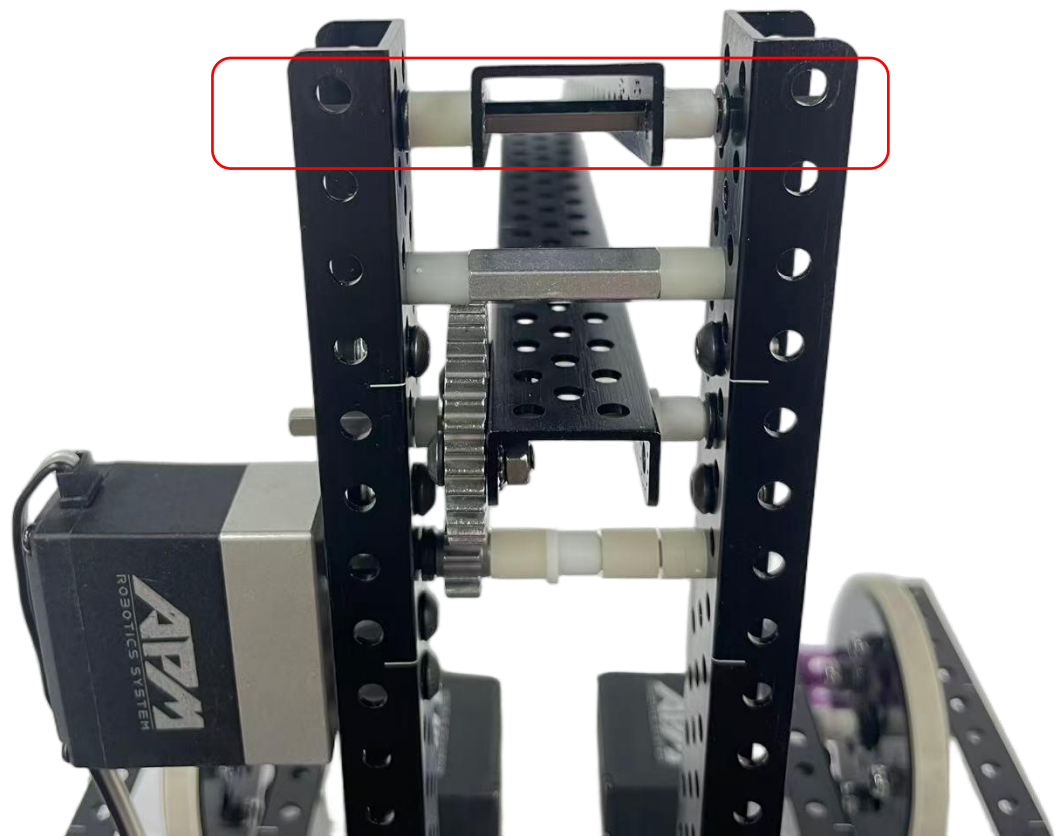
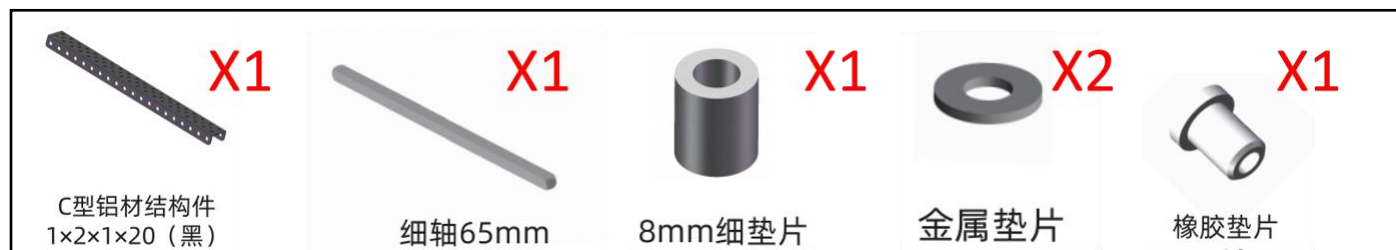

14

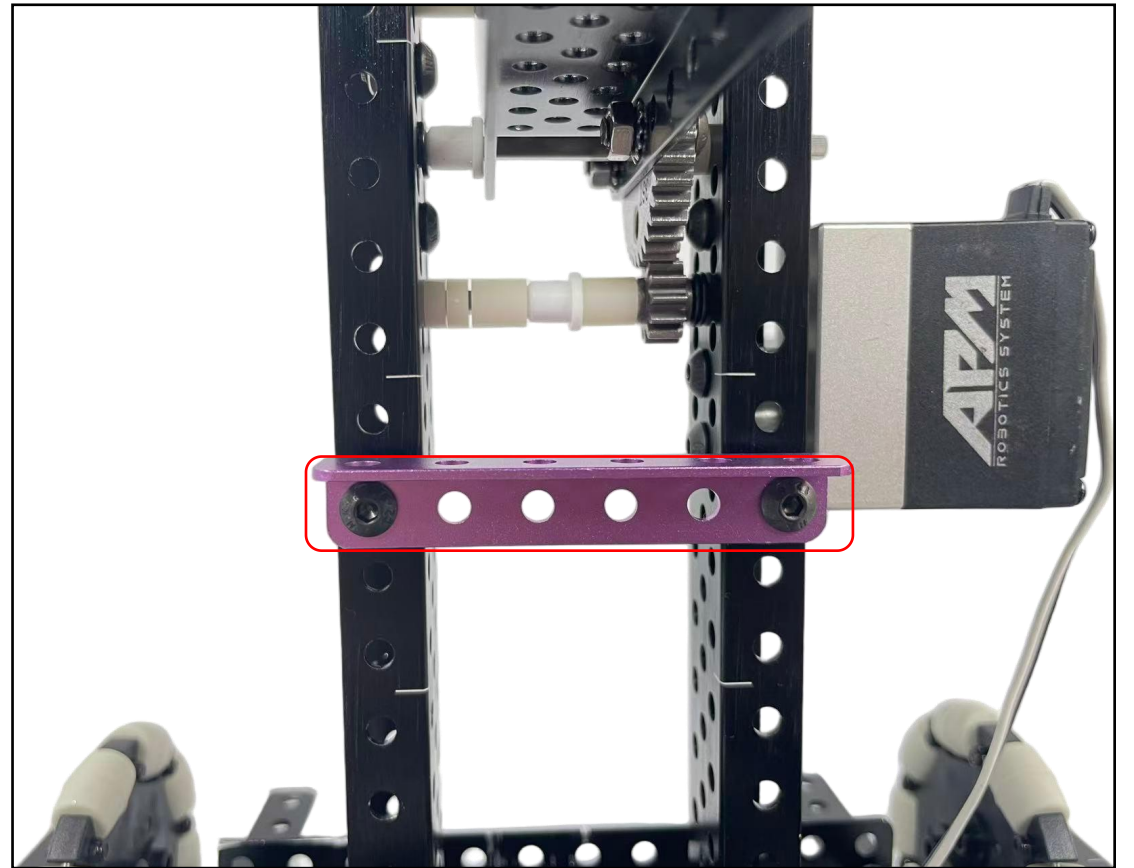

15

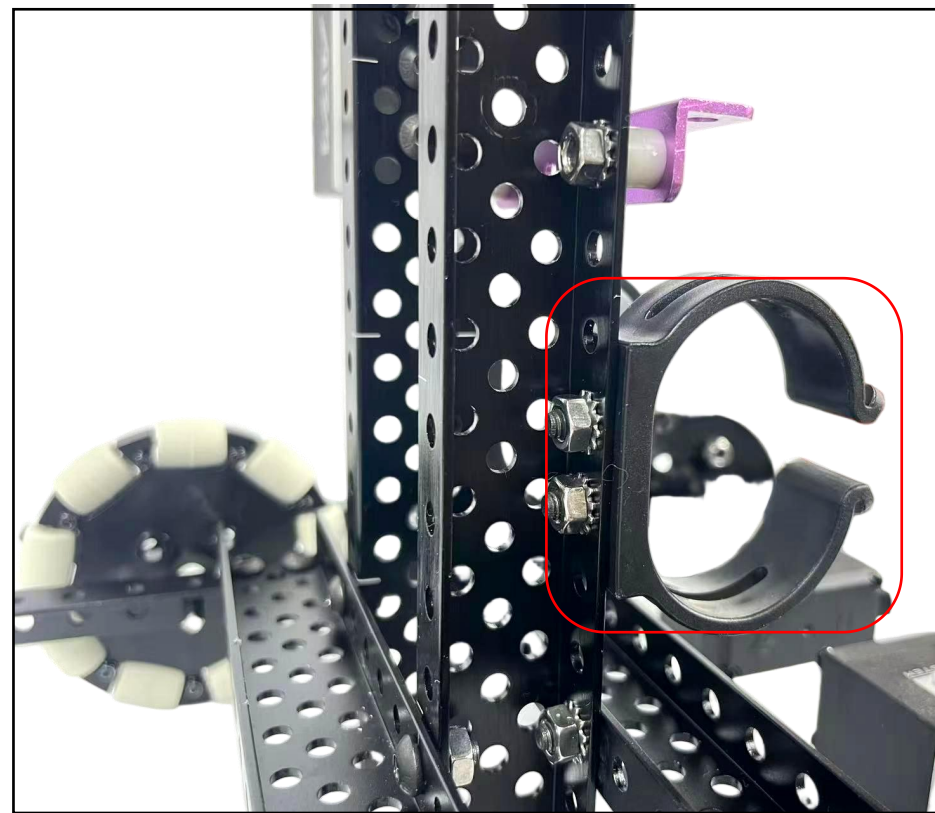
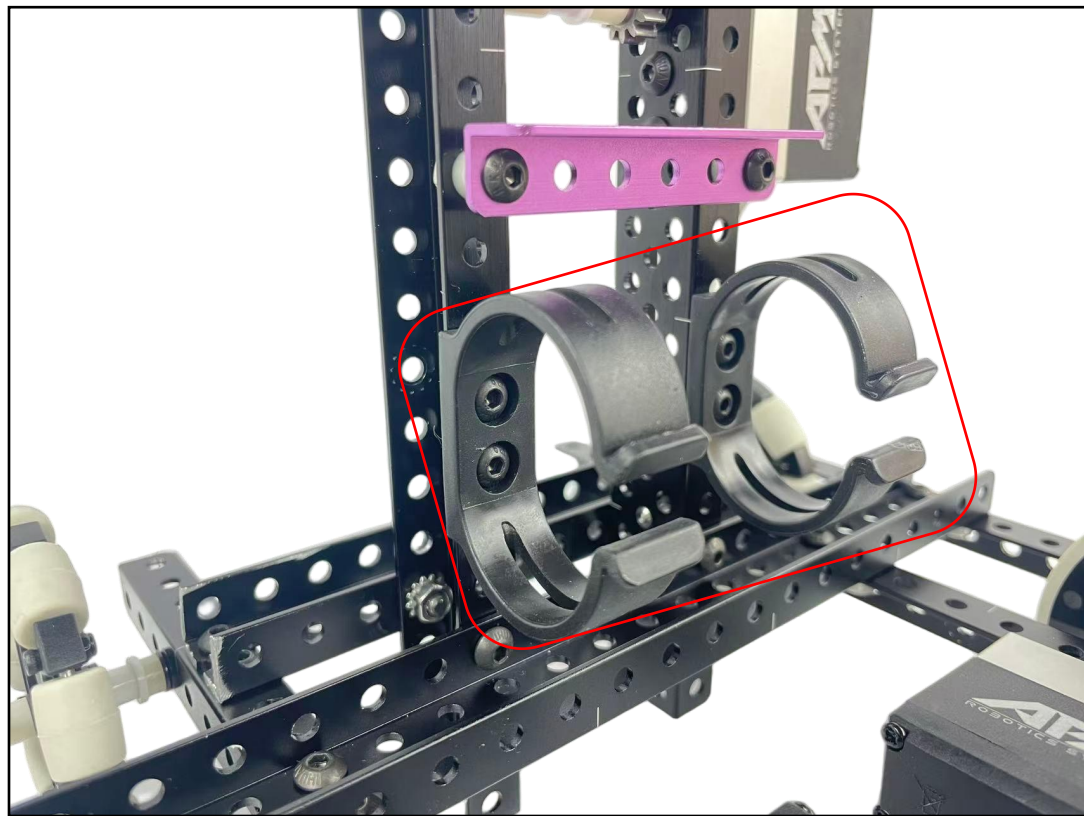

16

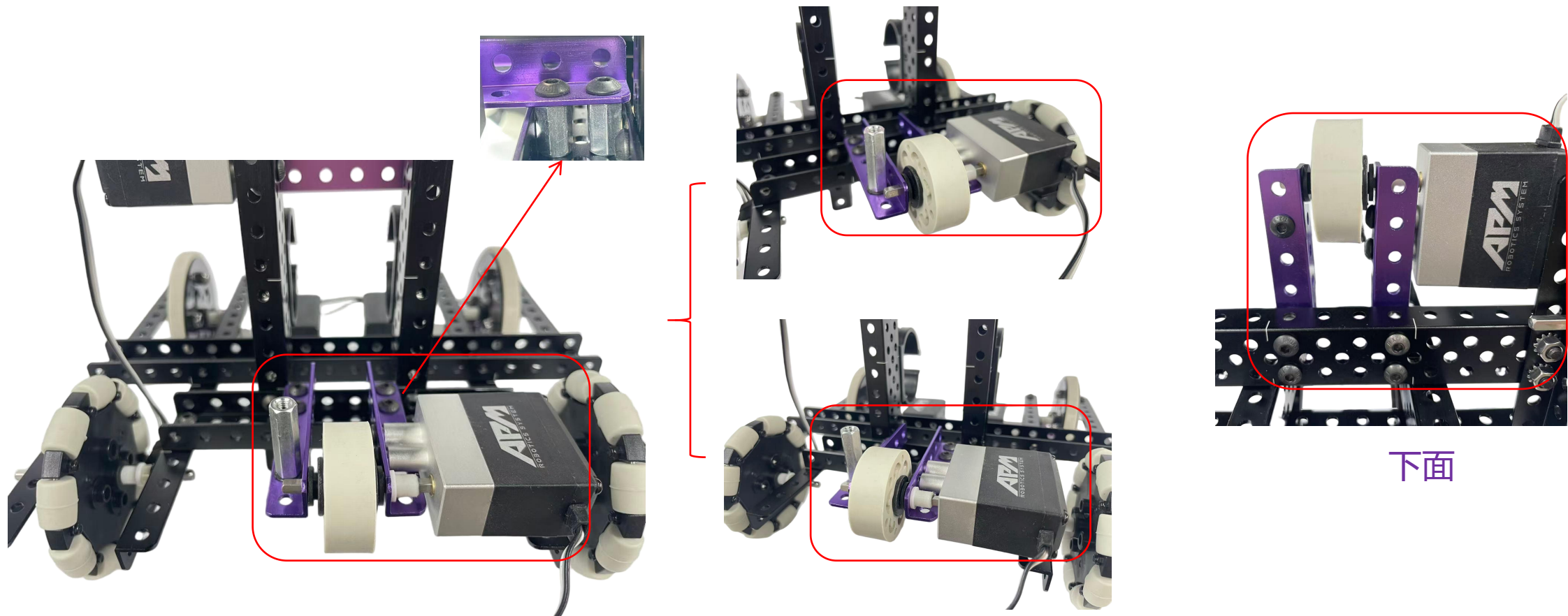

17

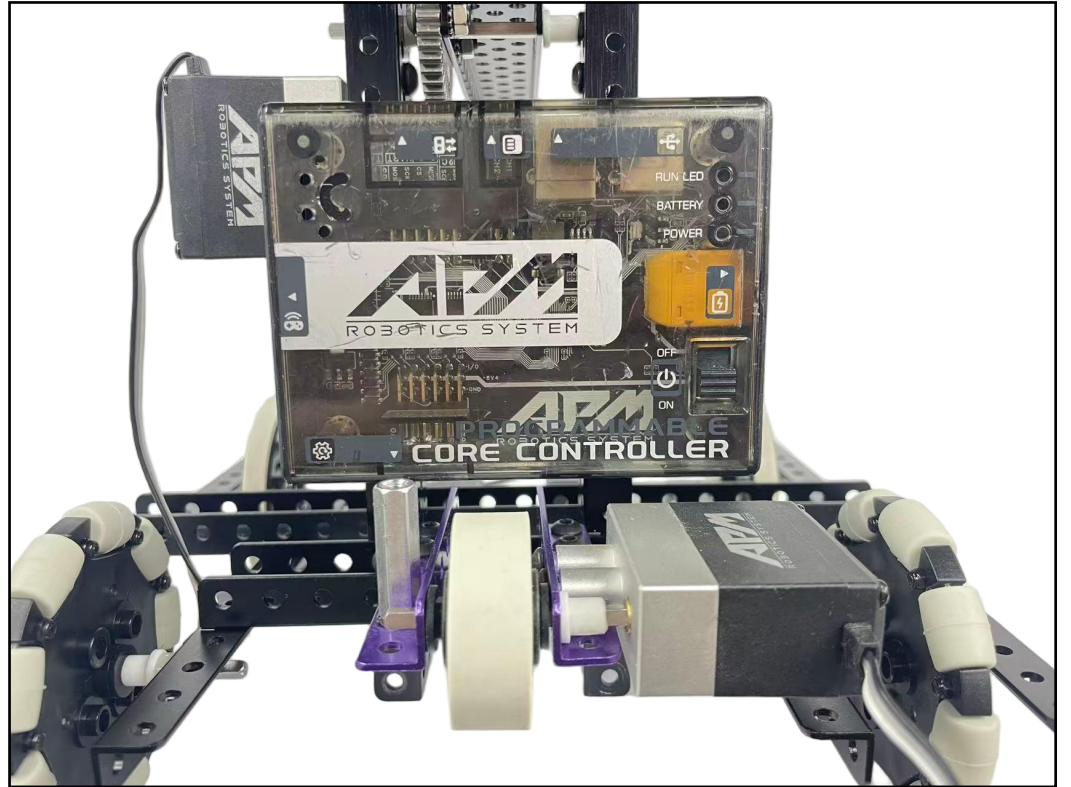
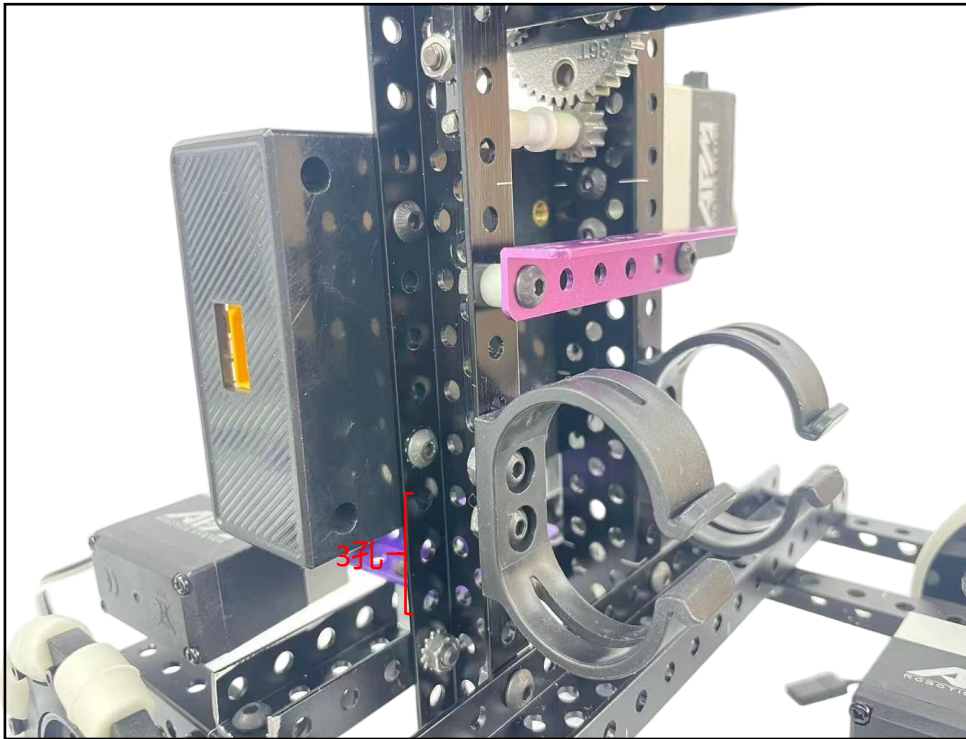

18

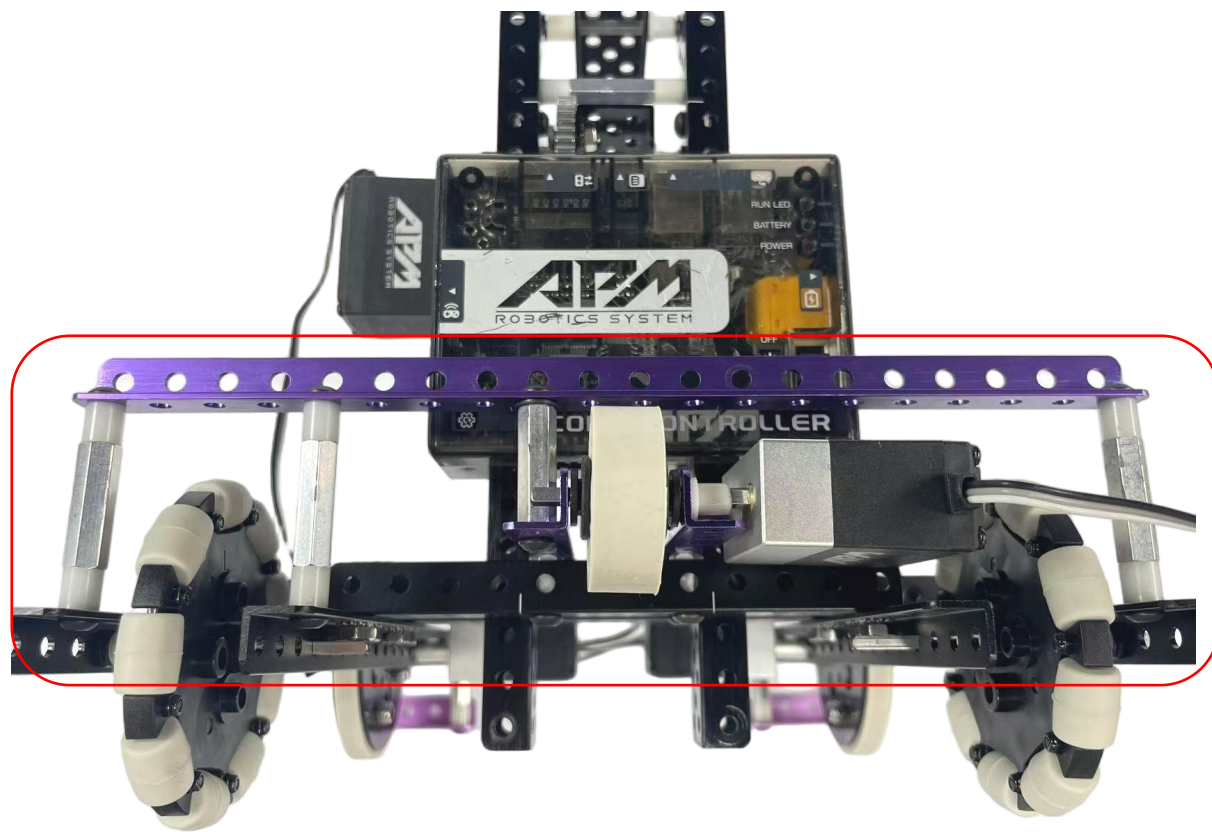
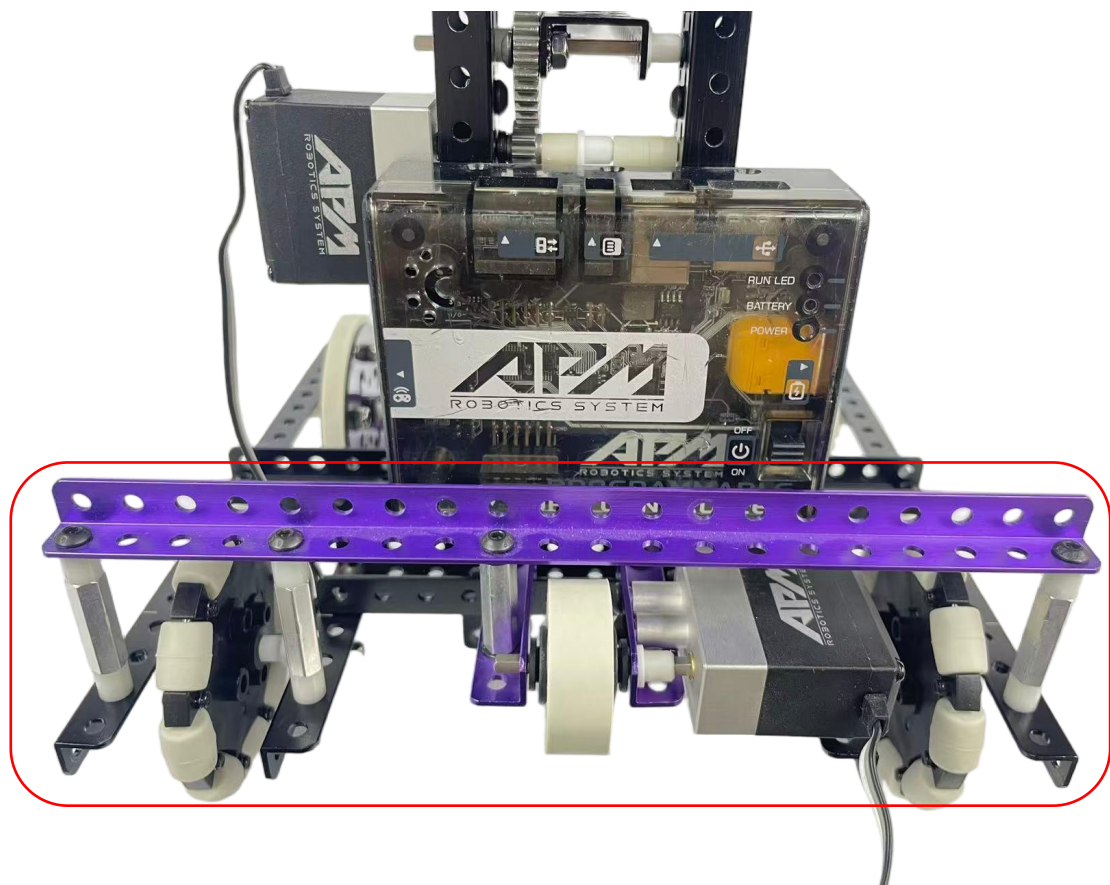
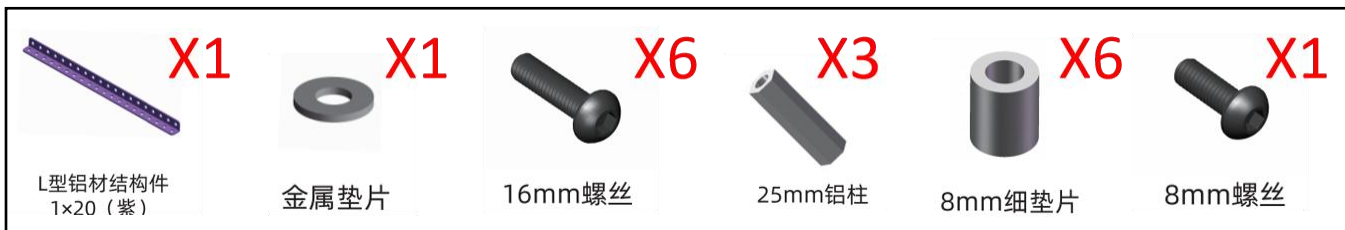

19

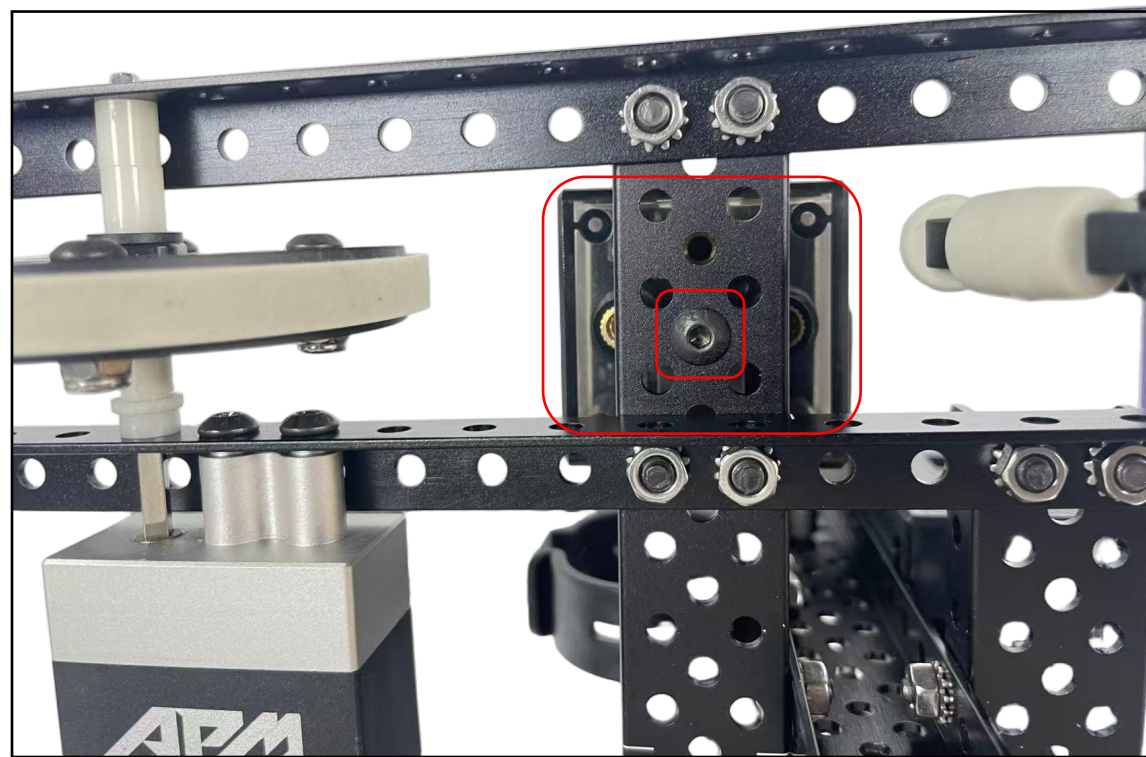
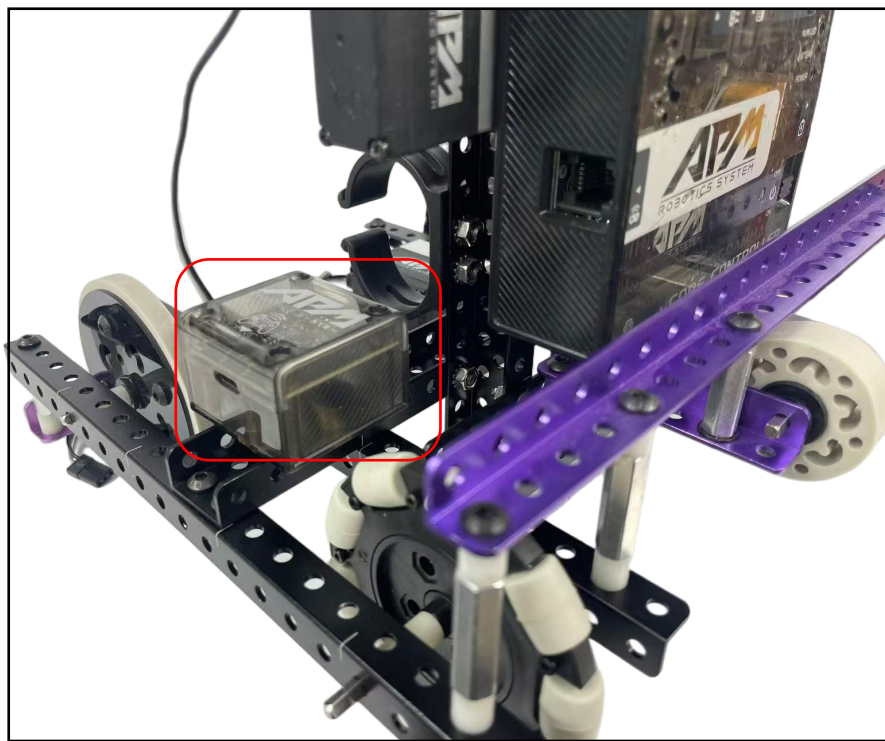
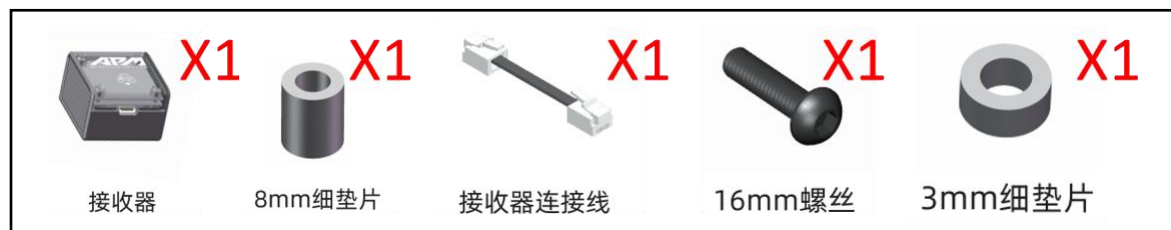

20

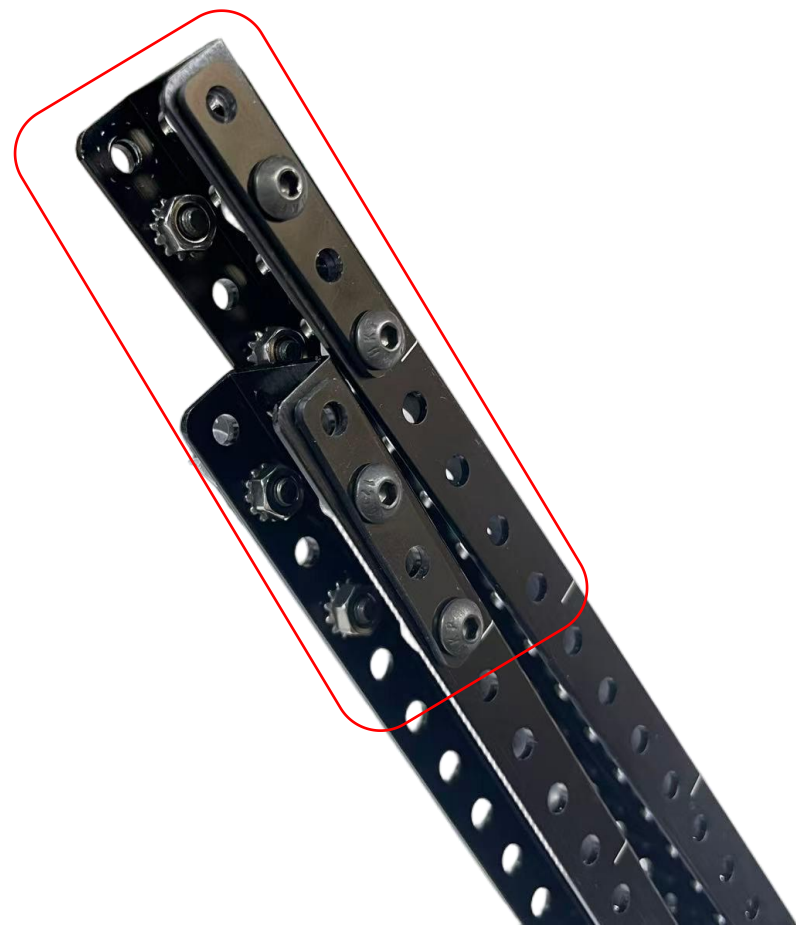
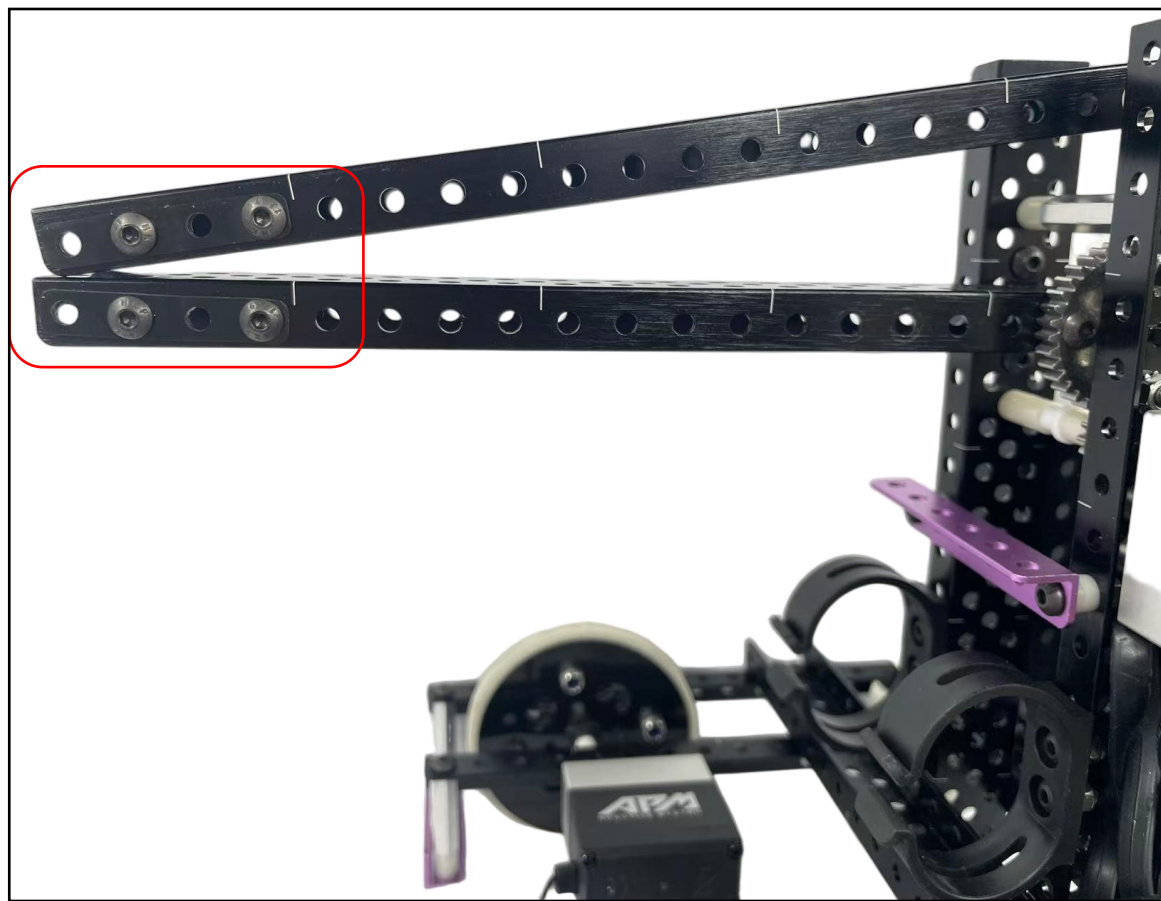

21

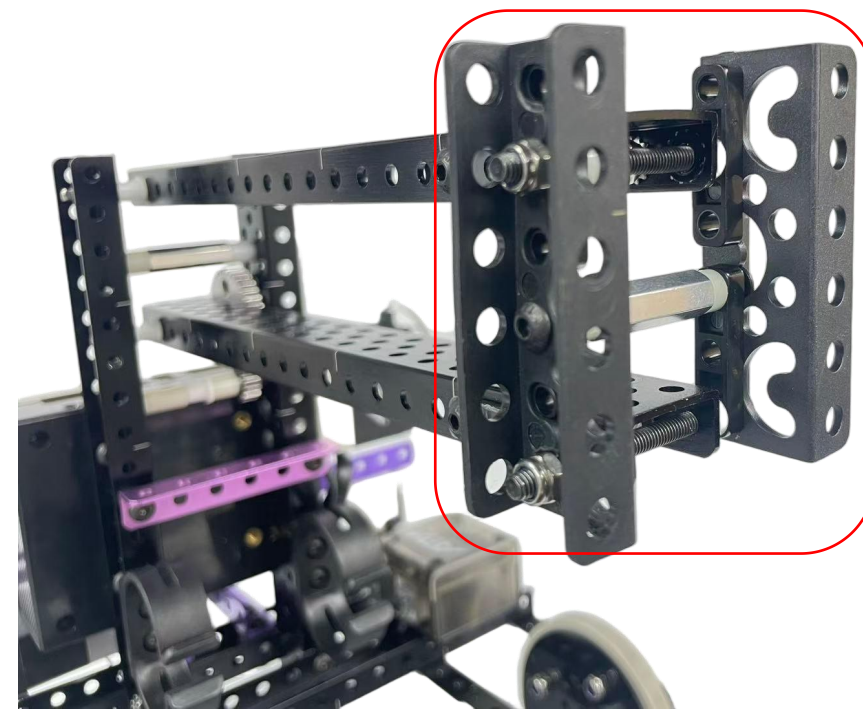
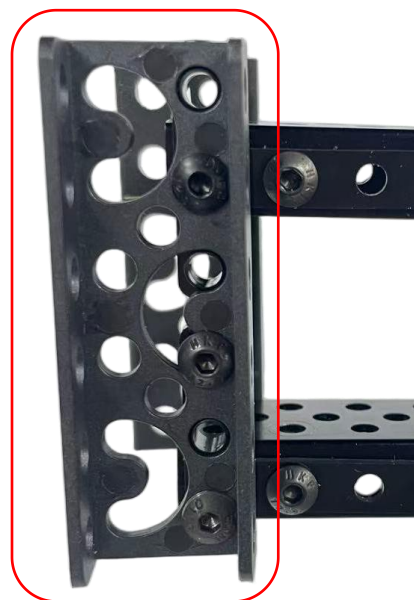
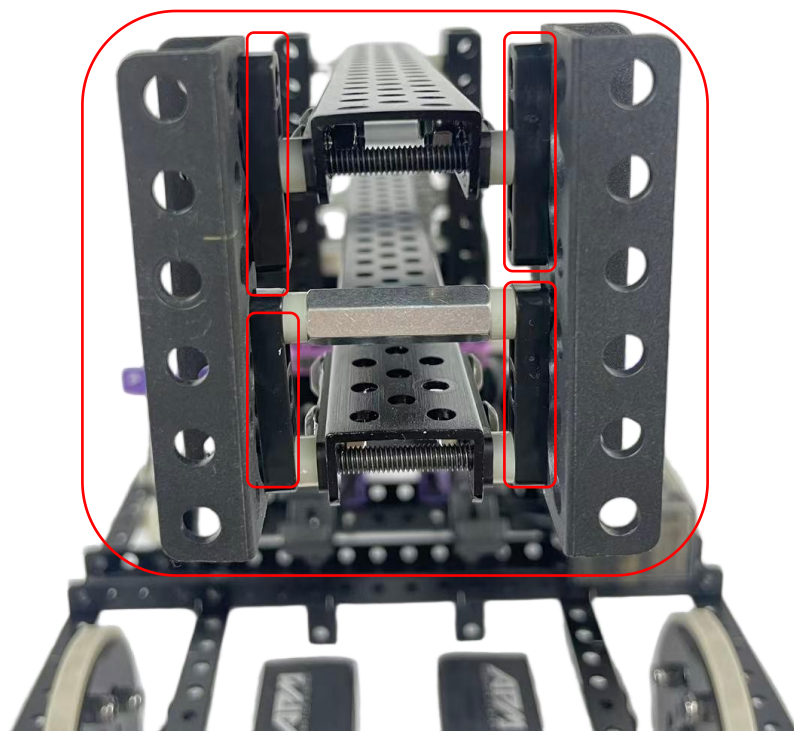

22



这一侧朝外

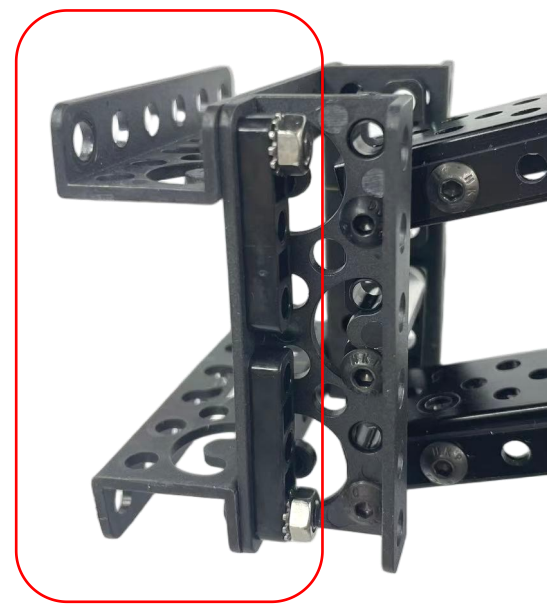
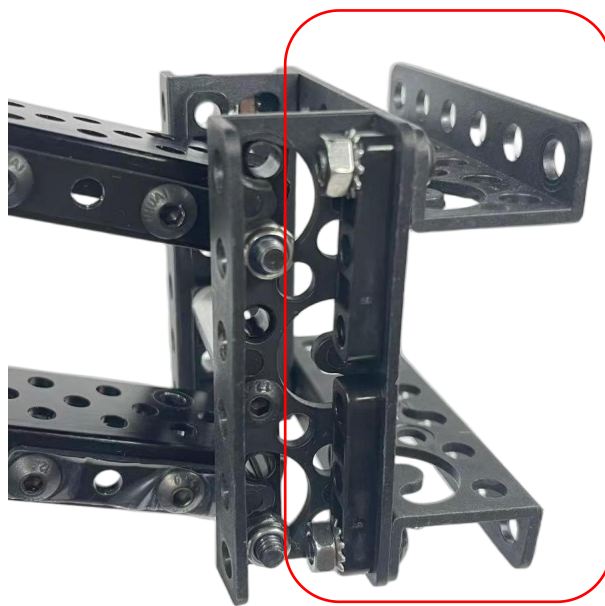
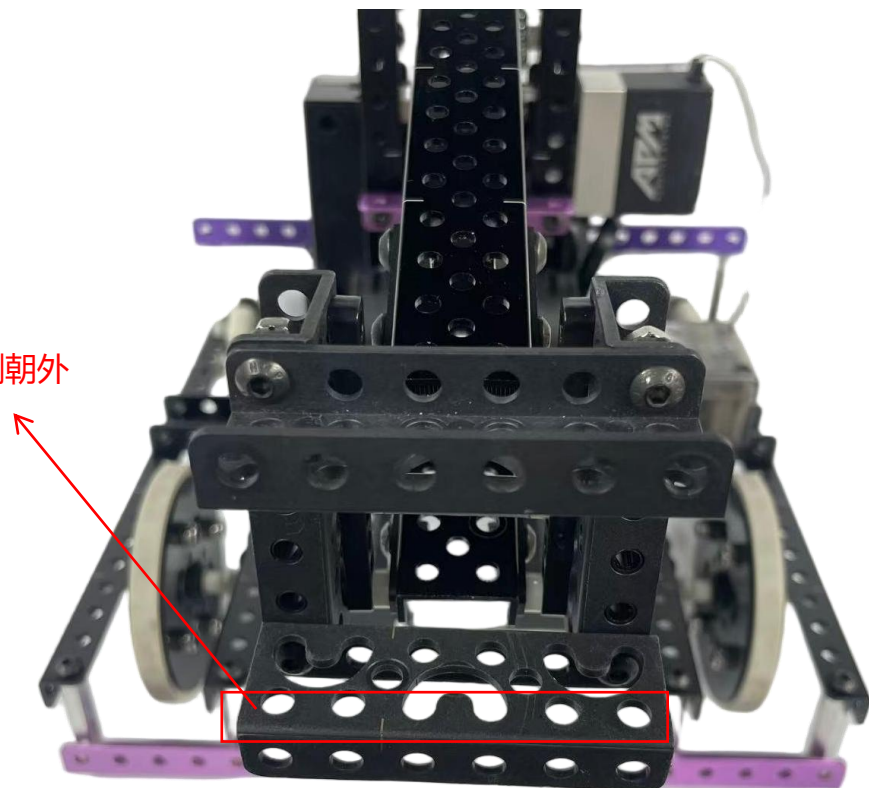

23

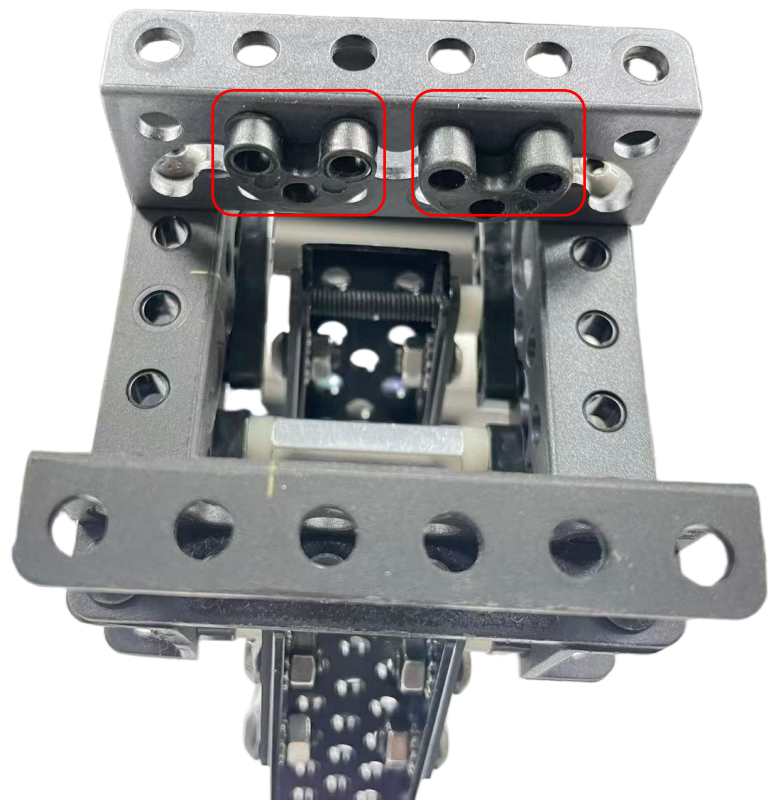
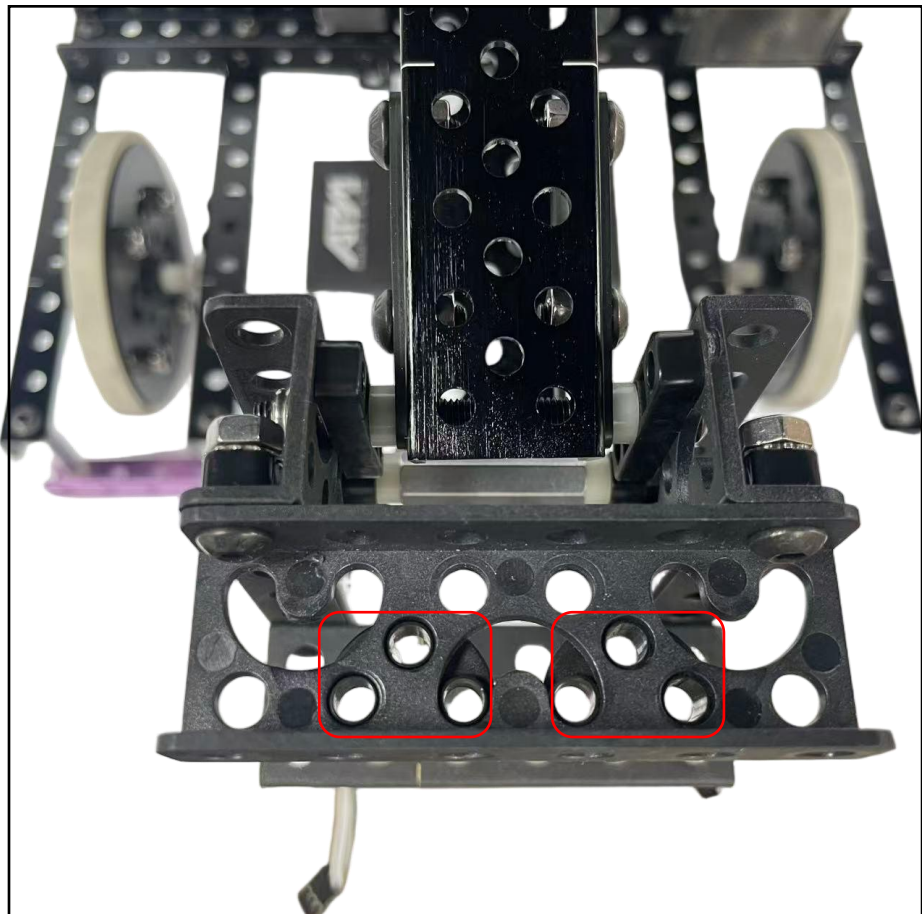

24

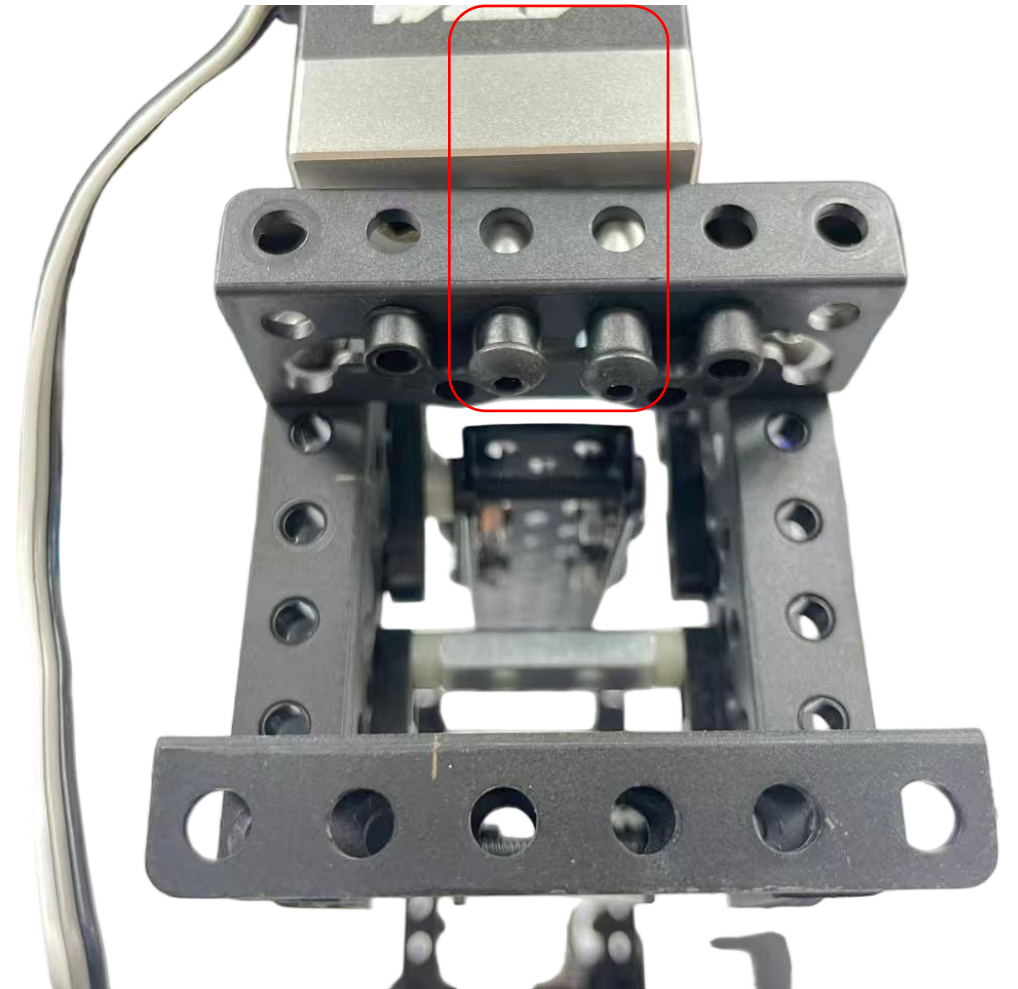
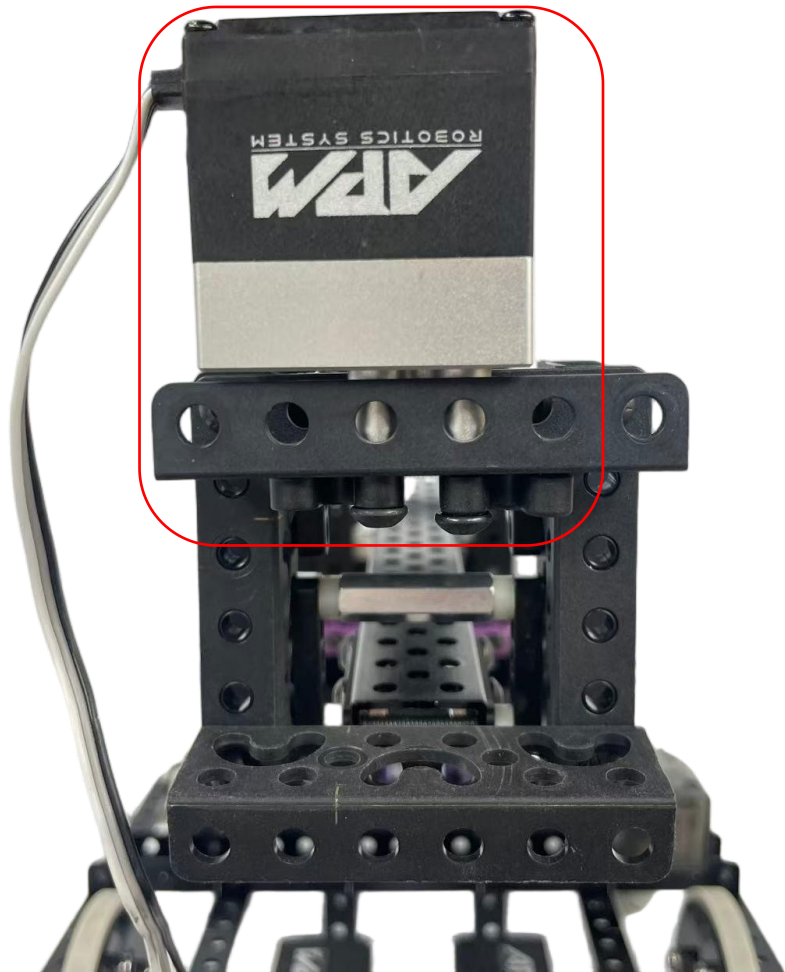

25

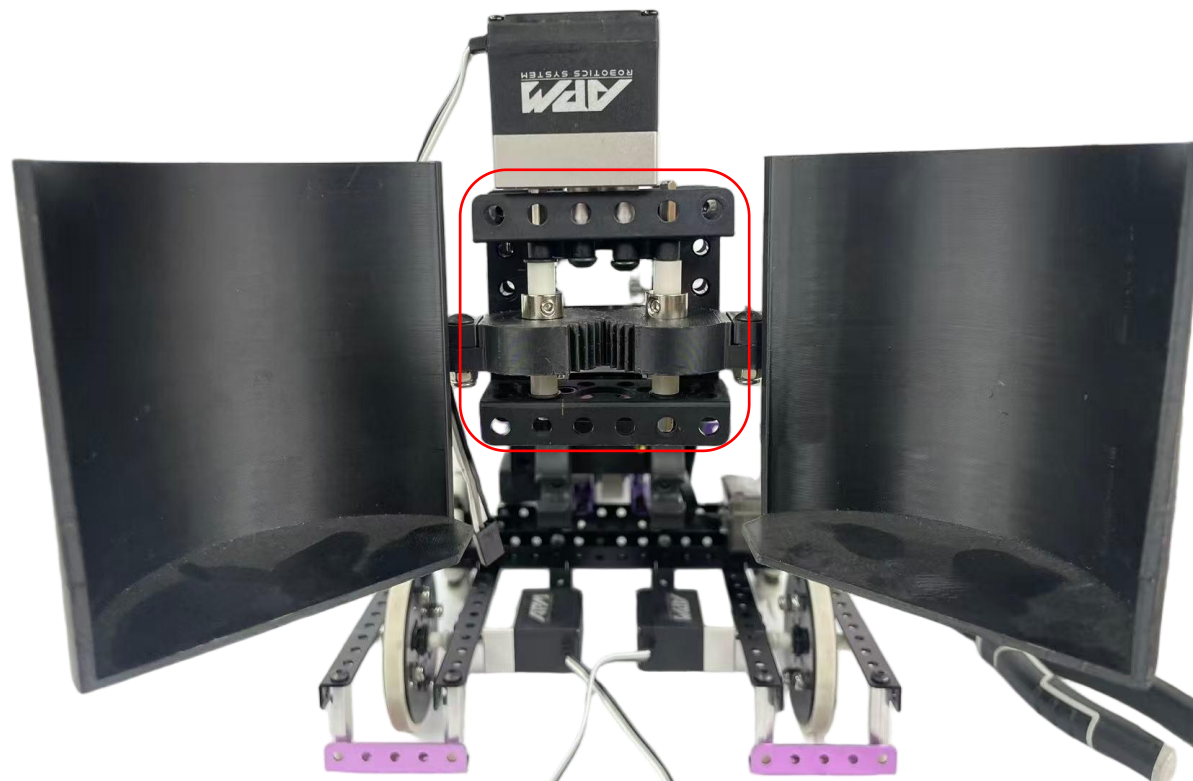
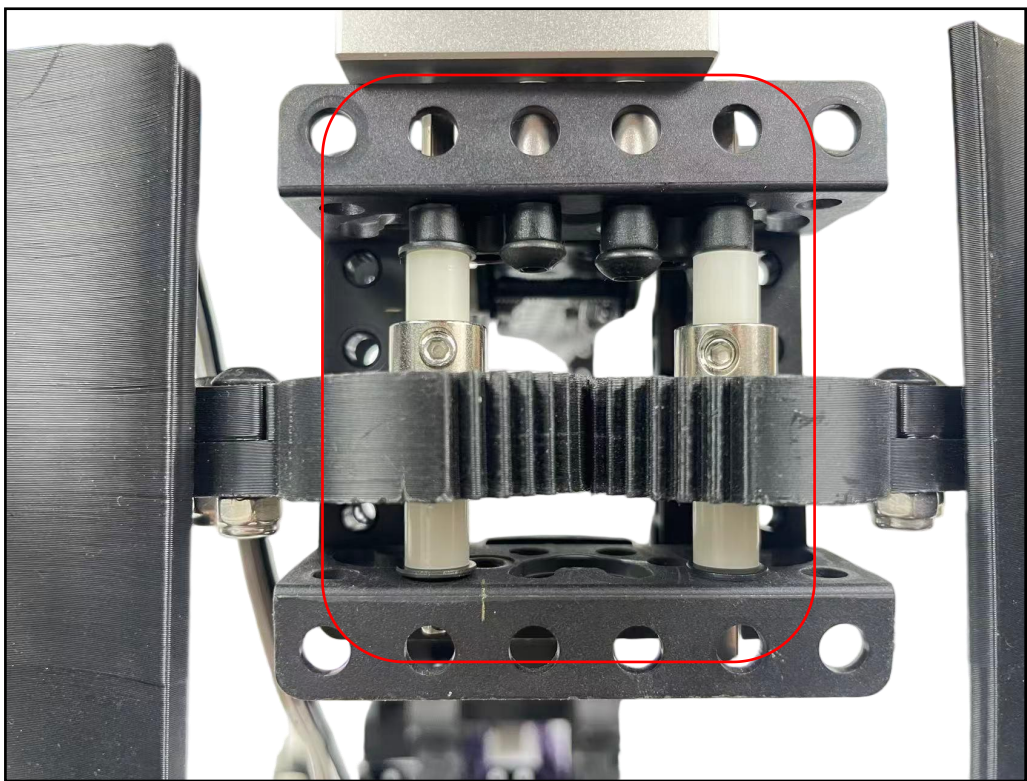

26

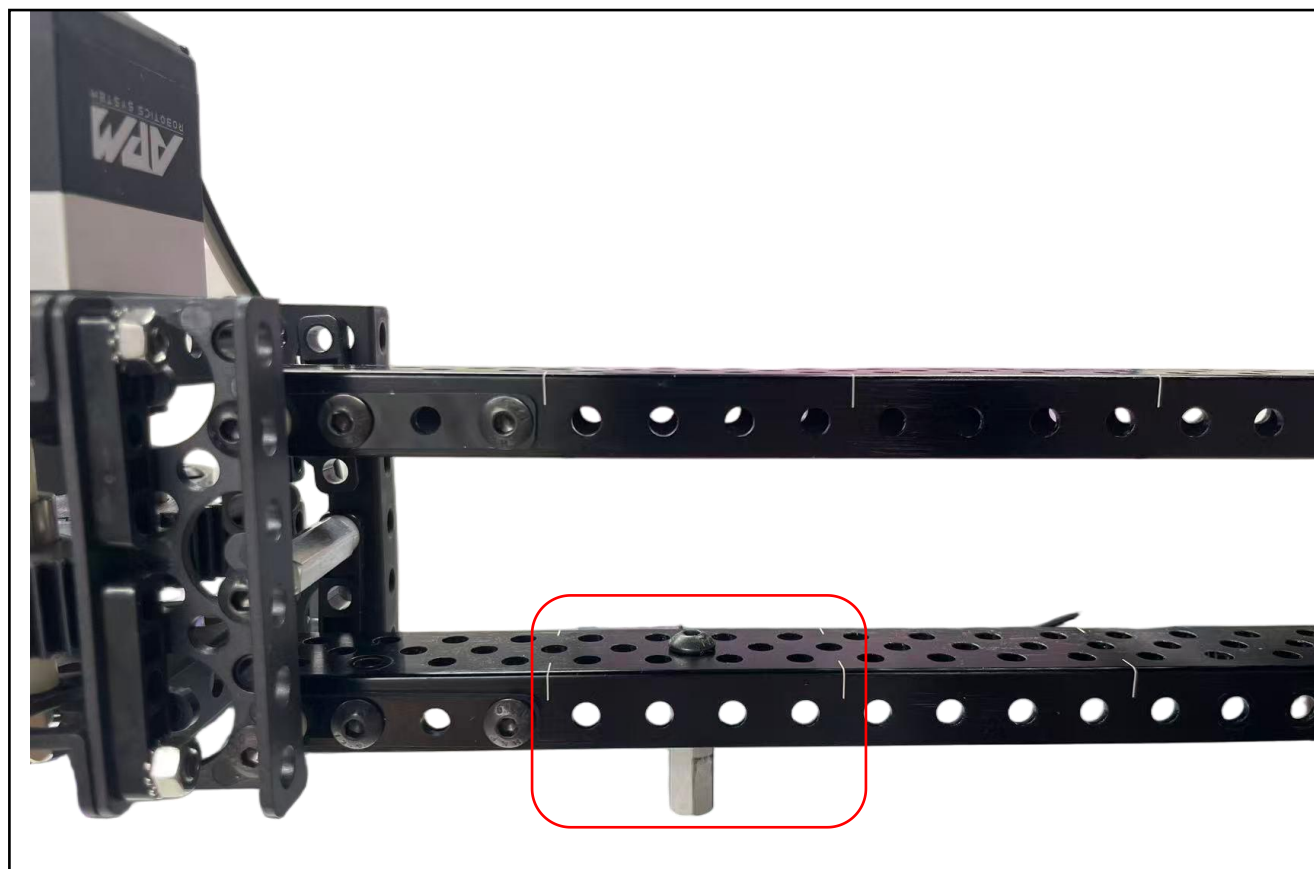

27

